

LS2208

PRODUCT REFERENCE GUIDE

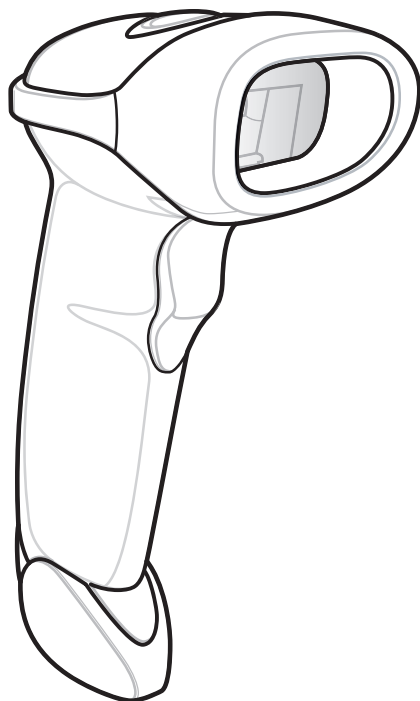

LS2208
PRODUCT REFERENCE GUIDE

MN000754A02

Revision A

March 2015

No part of this publication may be reproduced or used in any form, or by any electrical or mechanical means, without permission in writing. This includes electronic or mechanical means, such as photocopying, recording, or information storage and retrieval systems. The material in this manual is subject to change without notice.

The software is provided strictly on an “as is” basis. All software, including firmware, furnished to the user is on a licensed basis. We grant to the user a non-transferable and non-exclusive license to use each software or firmware program delivered hereunder (licensed program). Except as noted below, such license may not be assigned, sublicensed, or otherwise transferred by the user without our prior written consent. No right to copy a licensed program in whole or in part is granted, except as permitted under copyright law. The user shall not modify, merge, or incorporate any form or portion of a licensed program with other program material, create a derivative work from a licensed program, or use a licensed program in a network without our written permission. The user agrees to maintain our copyright notice on the licensed programs delivered hereunder, and to include the same on any authorized copies it makes, in whole or in part. The user agrees not to decompile, disassemble, decode, or reverse engineer any licensed program delivered to the user or any portion thereof.

Zebra reserves the right to make changes to any product to improve reliability, function, or design.

Zebra does not assume any product liability arising out of, or in connection with, the application or use of any product, circuit, or application described herein. No license is granted, either expressly or by implication, estoppel, or otherwise under any patent right or patent, covering or relating to any combination, system, apparatus, machine, material, method, or process in which Zebra products might be used. An implied license exists only for equipment, circuits, and subsystems contained in Zebra products.

Warranty

For the complete hardware product warranty statement, go to: <http://www.zebra.com/warranty>.

Revision History

Changes to the original guide are listed below:

Change	Date	Description
-01 Rev A	11/2014	Initial release
-02 Rev A	3/2015	Update URLs, update connector drawing

TABLE OF CONTENTS

About This Guide

Introduction	xiii
Scanner Configurations	xiii
Scanner Distinctions	xiii
Chapter Descriptions	xiv
Notational Conventions	xv
Related Documents	xv
Service Information	xvi

Chapter 1: GETTING STARTED

Introduction	1-1
Unpacking	1-1
Scanner Parts	1-2
Supported Interfaces	1-2
Setting Up the Scanner	1-3
Installing the Interface Cable	1-3
Connecting Power (if required)	1-3
Configuring the Scanner	1-3
Setting Up the Intellistand	1-4
Assembling the Stand	1-4
Mounting the Stand (optional)	1-5
Set Defaults	1-6

Chapter 2: SCANNING

Introduction	2-1
Beeper Definitions	2-1
LED Definitions	2-2
Scanning	2-3
Hands-Free Scanning	2-4
Aiming	2-4
Decode Ranges	2-5

Chapter 3: USB INTERFACE

Introduction	3-1
Connecting a USB Interface	3-2
USB Parameter Defaults	3-4
USB Host Parameters	3-5
USB Device Type	3-5
Symbol Native API (SNAPI) Status Handshaking	3-6
USB Keystroke Delay	3-7
USB CAPS Lock Override	3-7
USB Ignore Unknown Characters	3-8
USB Convert Unknown to Code 39	3-8
Emulate Keypad	3-9
Emulate Keypad with Leading Zero	3-9
Quick Keypad Emulation	3-10
USB Keyboard FN1 Substitution	3-10
Function Key Mapping	3-11
Simulated Caps Lock	3-11
Convert Case	3-12
USB Polling Interval	3-13
Fast HID Keyboard	3-14
USB Static CDC	3-15
Optional USB Parameters	3-16
TGCS (IBM) USB Ignore Beep Directive	3-16
TGCS (IBM) USB Ignore Bar Code Configuration Directive	3-16
ASCII Character Set for USB	3-17

Chapter 4: RS-232 INTERFACE

Introduction	4-1
Connecting an RS-232 Interface	4-2
RS-232 Parameter Defaults	4-3
RS-232 Host Parameters	4-4
RS-232 Host Types	4-6
Baud Rate	4-8
Stop Bits	4-9
Data Bits (ASCII Format)	4-10
Parity	4-11
Check Receive Errors	4-12
Hardware Handshaking	4-12
Software Handshaking	4-14
Host Serial Response Time-out	4-16
RTS Line State	4-17
Beep on <BEL>	4-17
Intercharacter Delay	4-18
Nixdorf Beep/LED Options	4-19
Ignore Unknown Characters	4-19
ASCII Character Set for RS-232	4-20

Chapter 5: IBM INTERFACE

Introduction	5-1
Connecting to an IBM 468X/469X Host	5-2
IBM Parameter Defaults	5-3
IBM 468X/469X Host Parameters	5-4
Port Address	5-4
Convert Unknown to Code 39	5-5
Optional IBM Parameters	5-5
Ignore Beep	5-5
Ignore Bar Code Configuration	5-6

Chapter 6: KEYBOARD WEDGE INTERFACE

Introduction	6-1
Connecting a Keyboard Wedge Interface	6-2
Keyboard Wedge Parameter Defaults	6-3
Keyboard Wedge Host Parameters	6-4
Keyboard Wedge Host Types	6-4
Ignore Unknown Characters	6-4
Keystroke Delay	6-5
Intra-Keystroke Delay	6-5
Alternate Numeric Keypad Emulation	6-6
Quick Keypad Emulation	6-6
Caps Lock On	6-7
Caps Lock Override	6-7
Convert Wedge Data	6-8
Function Key Mapping	6-8
FN1 Substitution	6-9
Send Make and Break	6-9
Keyboard Map	6-10
ASCII Character Set for Keyboard Wedge	6-11

Chapter 7: USER PREFERENCES & MISCELLANEOUS SCANNER OPTIONS

Introduction	7-1
Scanning Sequence Examples	7-1
Errors While Scanning	7-2
User Preferences Default Parameters	7-2
User Preferences	7-4
Set Defaults	7-4
Out of Box Experience	7-5
Report Version	7-6
Parameter Bar Code Scanning	7-7
Beep After Good Decode	7-7
Direct Decode Indicator	7-8
Suppress Power-up Beeps	7-8
Beeper Tone	7-9
Beeper Volume	7-10
Beeper Duration	7-11
Hand-Held Trigger Mode	7-12
Hands-Free Trigger Mode	7-13

Power Mode	7-14
Time Delay to Low Power Mode	7-15
Continuous Bar Code Read	7-17
Unique Bar Code Reporting	7-17
Decode Session Timeout	7-18
Timeout Between Decodes, Same Symbol	7-19
Timeout Between Decodes, Different Symbols	7-19
Miscellaneous Scanner Parameters	7-20
Transmit Code ID Character	7-20
Prefix/Suffix Values	7-21
Scan Data Transmission Format	7-22
FN1 Substitution Values	7-24
Transmit “No Read” Message	7-25
Unsolicited Heartbeat Interval	7-26
Enter Key (Carriage Return/Line Feed)	7-27
Tab Key	7-27

Chapter 8: SYMBOLOGIES

Introduction	8-1
Scanning Sequence Examples	8-1
Errors While Scanning	8-1
Symbology Parameter Defaults	8-2
Disable/Enable All Code Types	8-6
UPC/EAN	8-7
Enable/Disable UPC-A	8-7
Enable/Disable UPC-E	8-7
Enable/Disable UPC-E1	8-8
Enable/Disable EAN-8/JAN-8	8-8
Enable/Disable EAN-13/JAN-13	8-9
Enable/Disable Bookland EAN	8-9
Decode UPC/EAN/JAN Supplementals	8-10
User-Programmable Supplementals	8-13
UPC/EAN/JAN Supplemental Redundancy	8-13
UPC/EAN/JAN Supplemental AIM ID Format	8-14
Transmit UPC-A Check Digit	8-15
Transmit UPC-E Check Digit	8-15
Transmit UPC-E1 Check Digit	8-16
UPC-A Preamble	8-16
UPC-E Preamble	8-17
UPC-E1 Preamble	8-18
Convert UPC-E to UPC-A	8-19
Convert UPC-E1 to UPC-A	8-19
EAN-8/JAN-8 Extend	8-20
Bookland ISBN Format	8-20
UCC Coupon Extended Code	8-21
Coupon Report	8-21
ISSN EAN	8-22
Code 128	8-23
Enable/Disable Code 128	8-23
Set Length(s) for Code 128	8-23

Enable/Disable GS1-128 (formerly UCC/EAN-128)	8-25
Enable/Disable ISBT 128	8-25
ISBT Concatenation	8-26
Check ISBT Table	8-27
ISBT Concatenation Redundancy	8-27
Code 128 Security Level	8-28
Code 39	8-29
Enable/Disable Code 39	8-29
Enable/Disable Trioptic Code 39	8-29
Convert Code 39 to Code 32	8-30
Code 32 Prefix	8-30
Set Length(s) for Code 39	8-31
Code 39 Check Digit Verification	8-32
Transmit Code 39 Check Digit	8-32
Code 39 Full ASCII Conversion	8-33
Code 39 Buffering - Scan & Store	8-34
Code 39 Security Level	8-36
Code 93	8-37
Enable/Disable Code 93	8-37
Set Length(s) for Code 93	8-37
Code 11	8-39
Code 11	8-39
Set Length(s) for Code 11	8-39
Code 11 Check Digit Verification	8-41
Transmit Code 11 Check Digits	8-42
Interleaved 2 of 5 (ITF)	8-43
Enable/Disable Interleaved 2 of 5	8-43
Set Length(s) for Interleaved 2 of 5	8-43
I 2 of 5 Check Digit Verification	8-45
Transmit I 2 of 5 Check Digit	8-45
Convert I 2 of 5 to EAN-13	8-46
I 2 of 5 Security Level	8-47
Discrete 2 of 5 (DTF)	8-49
Enable/Disable Discrete 2 of 5	8-49
Set Length(s) for Discrete 2 of 5	8-49
Codabar (NW - 7)	8-51
Enable/Disable Codabar	8-51
Set Length(s) for Codabar	8-51
CLSI Editing	8-53
NOTIS Editing	8-53
Codabar Upper or Lower Case Start/Stop Characters Transmission	8-54
MSI	8-55
Enable/Disable MSI	8-55
Set Length(s) for MSI	8-55
MSI Check Digits	8-57
Transmit MSI Check Digit(s)	8-57
MSI Check Digit Algorithm	8-58
Chinese 2 of 5	8-59
Enable/Disable Chinese 2 of 5	8-59
Matrix 2 of 5	8-60
Enable/Disable Matrix 2 of 5	8-60

Set Length(s) for Matrix 2 of 5	8-60
Matrix 2 of 5 Check Digit	8-62
Transmit Matrix 2 of 5 Check Digit	8-62
Korean 3 of 5	8-63
Enable/Disable Korean 3 of 5	8-63
GS1 DataBar	8-64
GS1 DataBar-14	8-64
GS1 DataBar Limited	8-64
GS1 DataBar Expanded	8-65
GS1 DataBar Limited Security Level	8-65
Convert GS1 DataBar to UPC/EAN	8-67
Symbology-Specific Security Levels	8-68
Redundancy Level (Linear Code Type Security Level)	8-68
Bi-directional Redundancy	8-70
Security Level	8-71
Intercharacter Gap Size	8-72

Chapter 9: 123SCAN2

Introduction	9-1
Communication with 123Scan2	9-1
123Scan2 Requirements	9-2
Scanner SDK, Other Software Tools, and Videos	9-2

Chapter 10: ADVANCED DATA FORMATTING

Introduction	10-1
--------------------	------

Chapter 11: MAINTENANCE, TROUBLESHOOTING & TECHNICAL SPECIFICATIONS

Introduction	11-1
Maintenance	11-1
Troubleshooting	11-2
Technical Specifications	11-4
Scanner Signal Descriptions	11-6

Appendix A: STANDARD DEFAULT PARAMETERS

Introduction	B-1
--------------------	-----

Appendix B: COUNTRY CODES

Country Code Page Defaults	B-2
USB and Keyboard Wedge Country Keyboard Types (Country Codes)	B-6

Appendix C: PROGRAMMING REFERENCE

Symbol Code Identifiers	C-1
AIM Code Identifiers	C-2

Appendix D: SAMPLE BAR CODES

Code 39	D-1
UPC/EAN	D-1
UPC-A, 100%	D-1
EAN-13, 100%	D-2
Code 128	D-2
Interleaved 2 of 5	D-2
GS1 DataBar	D-3
GS1 DataBar-14	D-3

Appendix E: NUMERIC BAR CODES

Numeric Bar Codes	E-1
Cancel	E-3

Appendix F: ALPHANUMERIC BAR CODES

Alphanumeric Keyboard	F-1
-----------------------------	-----

Appendix G: ASCII CHARACTER SETS**Index**

ABOUT THIS GUIDE

Introduction

The *LS2208 Product Reference Guide* provides general instructions for setting up, operating, maintaining, and troubleshooting the LS2208 scanner.

Scanner Configurations

- LS2208-SR20001R
- LS2208-SR20007R

✓ **NOTE** Check Solution Builder for the latest available model configurations.

Scanner Distinctions

For certain features, this guide distinguishes between LS2208 scanners branded with a black logo vs. a silver logo:



Black Logo

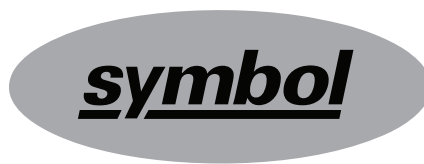

Silver Logo

Note the branding on your particular scanner to determine scanner behavior and features.

Chapter Descriptions

Topics covered in this guide are as follows:

- [Chapter 1, GETTING STARTED](#) provides a product overview, unpacking instructions, and cable connection information.
- [Chapter 2, SCANNING](#) describes parts of the scanner, beeper and LED definitions, and how to use the scanner.
- [Chapter 3, USB INTERFACE](#) provides information for setting up the scanner for USB operation.
- [Chapter 4, RS-232 INTERFACE](#) provides information for setting up the scanner for RS-232 operation.
- [Chapter 5, IBM INTERFACE](#) provides all information for setting up the scanner with IBM 468X/469X POS systems.
- [Chapter 6, KEYBOARD WEDGE INTERFACE](#) provides information for setting up the scanner for Keyboard Wedge operation.
- [Chapter 7, USER PREFERENCES & MISCELLANEOUS SCANNER OPTIONS](#) provides programming bar codes for selecting user preference features for the scanner and commonly used bar codes to customize how the data is transmitted to the host device.
- [Chapter 8, SYMBOLOGIES](#) describes all symbology features and provides the programming bar codes necessary for selecting these features for the scanner.
- [Chapter 9, 123SCAN2](#) (PC based scanner configuration tool) enables rapid and easy customized setup of scanners.
- [Chapter 10, ADVANCED DATA FORMATTING](#) (ADF) briefly describes ADF, a means of customizing data before transmission to the host device, and includes a reference to the *ADF Programmer Guide*.
- [Chapter 11, MAINTENANCE, TROUBLESHOOTING & TECHNICAL SPECIFICATIONS](#) provides information on how to care for the scanner, troubleshooting, and technical specifications.
- [Appendix A, STANDARD DEFAULT PARAMETERS](#) provides a table of all host devices and miscellaneous scanner defaults.
- [Appendix B, COUNTRY CODES](#) provides instructions for programming the keyboard to interface with a USB or Keyboard Wedge host.
- [Appendix C, PROGRAMMING REFERENCE](#) provides a table of AIM code identifiers, ASCII character conversions, and keyboard maps.
- [Appendix D, SAMPLE BAR CODES](#) includes sample bar codes.
- [Appendix E, NUMERIC BAR CODES](#) includes the numeric bar codes to scan for parameters requiring specific numeric values.
- [Appendix F, ALPHANUMERIC BAR CODES](#) includes the bar codes representing the alphanumeric keyboard, used when setting ADF rules.
- [Appendix G, ASCII CHARACTER SETS](#) provides ASCII character value tables.

Notational Conventions

The following conventions are used in this document:

- *Italics* are used to highlight chapters and sections in this and related documents.
- **Bold** text is used to highlight parameter names and options.
- bullets (•) indicate:
 - Action items
 - Lists of alternatives
 - Lists of required steps that are not necessarily sequential
- Sequential lists (e.g., those that describe step-by-step procedures) appear as numbered lists.
- Throughout the programming bar code menus, asterisks (*) are used to denote default parameter settings.



*Indicates Default — ***Baud Rate 9600** — Feature/Option



NOTE This symbol indicates something of special interest or importance to the reader. Failure to read the note will not result in physical harm to the reader, equipment or data.



CAUTION This symbol indicates that if this information is ignored, the possibility of data or material damage may occur.



WARNING! This symbol indicates that if this information is ignored the possibility that serious personal injury may occur.

Related Documents

- The *LS2208 Quick Start Guide* (p/n MN000753Axx) provides general information to help the user get started with the scanner. It includes basic operation instructions and start up bar codes.

The latest version of this guide and all guides, are available at: <http://www.zebra.com/support>.

Service Information

If you have a problem using the equipment, contact your facility's technical or systems support. If there is a problem with the equipment, they will contact the Support Center at: <http://www.zebra.com/support>.

When contacting support, please have the following information available:

- Serial number of the unit
- Model number or product name
- Software type and version number

We respond to calls by e-mail, telephone or fax within the time limits set forth in service agreements.

If your problem cannot be solved by support, you may need to return your equipment for servicing and will be given specific directions. We are not responsible for any damages incurred during shipment if the approved shipping container is not used. Shipping the units improperly can possibly void the warranty.

If you purchased your business product from a business partner, please contact that business partner for support.

CHAPTER 1 GETTING STARTED

Introduction

The LS2208 scanner combines excellent scanning performance and advanced ergonomics to provide the best value in a lightweight laser scanner. Whether used as a hand-held scanner or in hands-free mode in a stand, the scanner ensures reliability, comfort and ease of use for extended periods of time.

Unpacking

Remove the scanner from their respective packing and inspect for damage. If the scanner was damaged in transit, contact the Global Customer Support Center. See [page xvi](#) for contact information. **KEEP THE PACKING.** It is the approved shipping container and should be used if the equipment ever needs to be returned for servicing.

Scanner Parts



Figure 1-1 Scanner Parts

Supported Interfaces

The LS2208 scanner supports connection to the following host interfaces:

- USB. The scanner automatically detects a USB host and uses the default setting (HID keyboard interface type). If the default does not meet your requirements, scan another USB host bar code on [page 3-5](#).
- Standard RS-232. The scanner automatically detects an RS-232 host and uses the default setting (standard RS-232). If the default does not meet your requirements, scan another RS-232 host bar code on [page 4-6](#).
- IBM 468X/469X. Scanners branded with a silver logo **symbol** **must** use auto-host detect cables, and automatically detect an IBM host, but there is no default setting. Select a [Port Address on page 5-4](#) for the appropriate port.

Scanners branded with a black logo **symbol** **must** use a standard IBM cable. Select a [Port Address on page 5-4](#) for the appropriate port.

- Keyboard wedge. Scanners branded with a silver logo **symbol** using auto-host detect cables automatically detect a keyboard wedge host and use the default setting (IBM PC/AT & IBM PC Compatibles). If the default does not meet your requirements, scan the IBM AT Notebook bar code on [page 6-4](#). The host interprets scanned data as keystrokes. Scanners using a standard keyboard wedge cable **must** select a keyboard wedge host on [page 6-4](#).

Scanners branded with a black logo **symbol** do not auto-host detect and **must** select a keyboard wedge host on [page 6-4](#).

- International keyboards for USB and keyboard wedge (scanners branded with a silver logo only **symbol**). See [Appendix B, COUNTRY CODES](#) for available keyboards.

Setting Up the Scanner

Installing the Interface Cable

1. Plug the interface cable modular connector into the cable interface port on the bottom of the scanner handle.
2. Gently tug the cable to ensure the connector is properly secured.
3. Connect the other end of the interface cable to the host (see the specific host chapter for information on host connections).

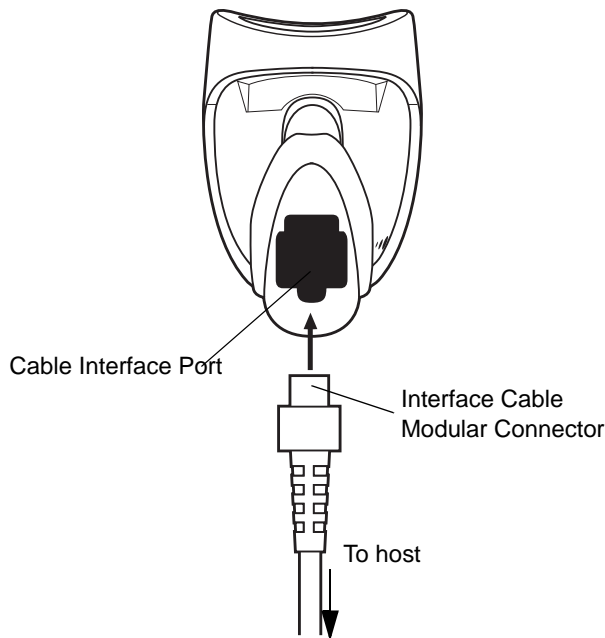

Figure 1-2 *Installing the Cable*

✓ **NOTE** Different hosts require different cables. The connectors illustrated in each host chapter are examples only. Your connectors may be different than those illustrated, but the steps to connect the scanner are the same.

Connecting Power (if required)

If the host does not provide power to the scanner, use an external power connection to the scanner. After installing the interface cable, plug the power supply into the power jack on the interface cable. Plug the other end of the power supply into an AC outlet.

Configuring the Scanner

Use the bar codes in this manual or the 123Scan² configuration program to configure the scanner. See [Chapter 7, USER PREFERENCES & MISCELLANEOUS SCANNER OPTIONS](#) for information about programming the scanner using bar code menus. Also see each host-specific chapter to set up connection to a specific host type. See [Chapter 9, 123SCAN2](#) to configure the scanner using this configuration program.

Setting Up the Intellistand

The LS2208 Intellistand adds greater flexibility to scanning operation. See [Hands-Free Scanning on page 2-4](#) for more information about hands-free scanning.

Assembling the Stand

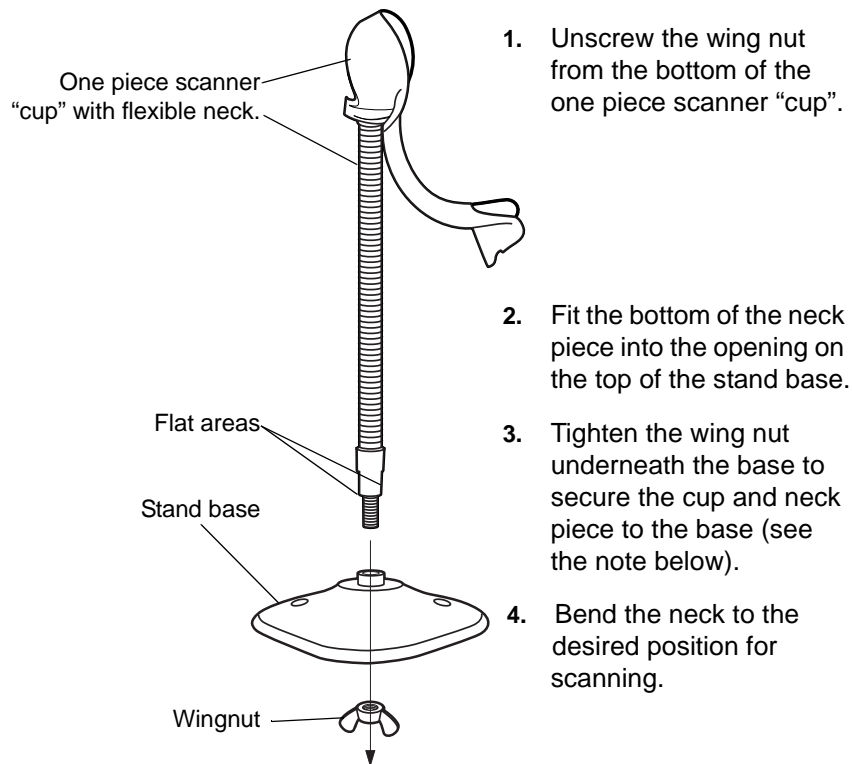

Figure 1-3 *Assembling the Stand*



NOTE Before tightening the wing nut under the base, ensure that the flat areas on the flexible neck fit securely in the grooves in the base.

Mounting the Stand (optional)

You can attach the base of the scanner's stand to a flat surface using two screws or double-sided tape (not provided).

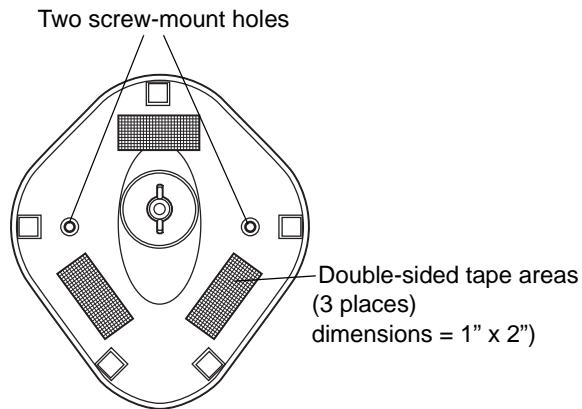

Figure 1-4 *Mounting the Stand*

Screw Mount

1. Position the assembled base on a flat surface.
2. Screw one #10 wood screw into each screw-mount hole until the base of the stand is secure.

Tape Mount

1. Peel the paper liner off one side of each piece of tape and place the sticky surface over each of the three rectangular tape holders.
2. Peel the paper liner off the exposed sides of each piece of tape and press the stand on a flat surface until it is secure.

Set Defaults

Scan the following bar code to reset the scanner to its factory default settings. This bar code is also available in [User Preferences on page 7-4](#).



***Set Factory Defaults**

CHAPTER 2 SCANNING

Introduction

This chapter provides beeper and LED definitions, scanning techniques, general instructions and tips about scanning, and decode ranges.

Beeper Definitions

The scanner communicates by emitting different beeper sequences and patterns. [Table 2-1](#) defines beep sequences that occur during both normal scanning and while programming the scanner.

Table 2-1 *Standard Beeper Definitions*

Beeper Sequence	Indication
Standard Use	
Low/medium/high beep	Power up.
Short high beep	A bar code symbol was decoded (if decode beeper is enabled).
4 long low beeps	A transmission error was detected in a scanned symbol. The data is ignored. This occurs if a unit is not properly configured. Check option setting.
5 low beeps	Conversion or format error.
Low/high/low beep	ADF transmit error.
High/high/high/low beep	RS-232 receive error.
Parameter Menu Scanning	
Short high beep	Correct entry scanned or correct menu sequence performed.
Low/high beep	Input error, incorrect bar code or "Cancel" scanned, wrong entry, incorrect bar code programming sequence; remain in program mode.

Table 2-1 Standard Beeper Definitions (Continued)

Beeper Sequence	Indication
High/low beep	Keyboard parameter selected. Enter value using bar code keypad.
High/low/high/low beep	Successful program exit with change in the parameter setting.
Low/high/low/high beep	Out of host parameter storage space. Scan Set Defaults on page 7-4 .
Code 39 Buffering	
High/low beep	New Code 39 data was entered into the buffer.
3 Beeps - long high beep	Code 39 buffer is full.
Low/high/low beep	The Code 39 buffer was erased or there was an attempt to clear or transmit an empty buffer.
Low/high beep	A successful transmission of buffered data.
Host Specific	
USB only	
4 short high beeps	Scanner has not completed initialization. Wait several seconds and scan again.
Scanner gives a power-up beep after scanning a USB Device Type.	Communication with the bus must be established before the scanner can operate at the highest power level.
This power-up beep occurs more than once.	The USB bus may put the scanner in a state where power to the scanner is cycled on and off more than once. This is normal and usually happens when the PC cold boots.
RS-232 only	
1 short high beep	A <BEL> character is received and Beep on <BEL> is enabled.

LED Definitions

In addition to beeper sequences, the scanner communicates using a two-color LED display. [Table 2-2](#) defines LED colors that display during scanning.

Table 2-2 Standard LED Definitions

Indication	LED
No power is applied to the scanner.	Off
The scanner is on and ready to scan.	Off
A bar code was successfully decoded.	Green
A data transmission error or scanner malfunction occurred.	Red

Scanning

When scanning, the scanner projects a red laser line which should be placed across the bar code as shown in [Figure 2-1](#). See [Decode Ranges on page 2-5](#) for the proper distance to achieve between the scanner and a bar code.

Hand-Held Scanning

To scan:

1. Ensure all connections are secure (see the appropriate host chapter).
2. Aim the scanner at the bar code.
3. Press the trigger.

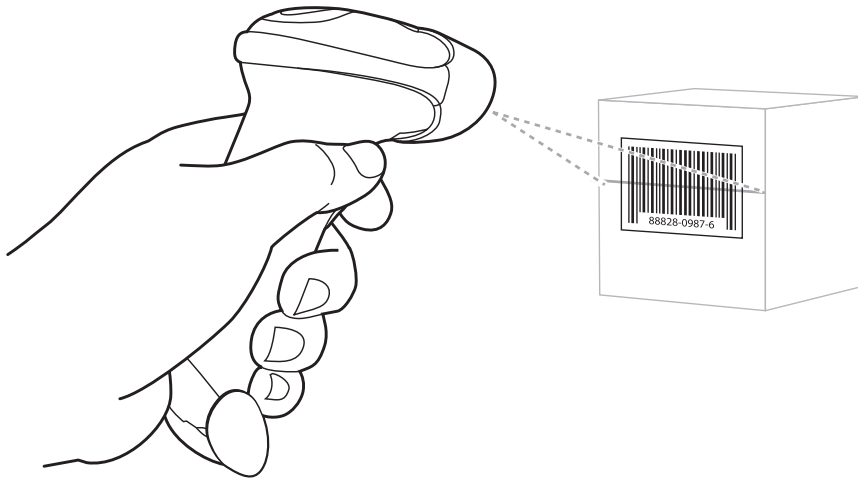
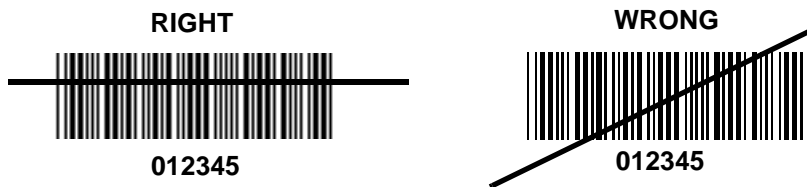

Figure 2-1 Scanning

4. Ensure the scan line crosses every bar and space of the symbol.



5. Upon successful decode, the scanner beeps and the LED turns green. For more information on beeper and LED definitions, see [Table 2-1](#) and [Table 2-2](#).

Hands-Free Scanning

The optional Intellistand adds greater flexibility to scanning operation. For information on assembling the stand, see [Setting Up the Intellistand on page 1-4](#).

When the scanner is seated in the stand's "cup", the scanner's built-in sensor places the scanner in hands-free mode. When you remove the scanner from the stand it operates in hand-held mode.

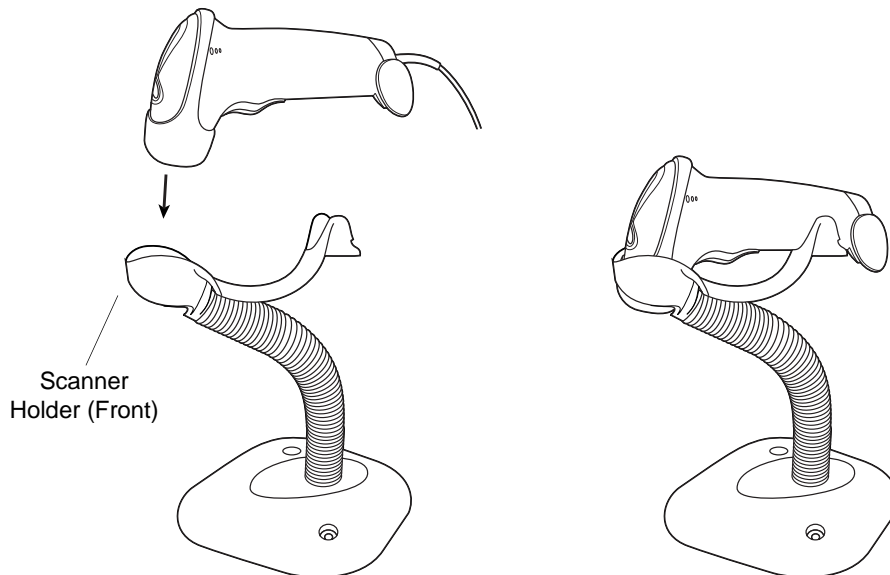

Figure 2-2 *Inserting the Scanner in the Stand*

To scan in hands-free mode:

1. Ensure all cable connections are secure.
2. Insert the scanner in the optional Intellistand by placing the front of the scanner into the stand's "cup".
3. To scan a bar code, present the bar code and ensure the scan line crosses every bar and space of the symbol.
4. Upon successful decode, the scanner beeps and the LED turns green momentarily.

Aiming

Do not position the scanner and bar code at a 90° angle to each other. Laser light reflecting *directly* back into the scanner from the bar code is known as specular reflection. This specular reflection can make decoding difficult. Tilt the scanner or bar code up to 55° forward or back and achieve a successful decode. Simple practice quickly shows what tolerances to work within.

Decode Ranges

Table 2-3 *LS2208 Decode Ranges*

Symbol Density	Typical Working Ranges	
	Near	Far
Code 39 - 5 mil	2.5 in. (6.35 cm)	6.0 in. (15.24 cm)
Code 39 - 7.5 mil	1.5 in. (3.81 cm)	10.0 in. (25.40 cm)
Code 39 - 10 mil	1.0 in. (2.54 cm)	14.5 in. (36.83 cm)
100% UPC - 13 mil	0.0 in. (0.0 cm)	17.0 in. (43.18 cm)
Code 39 - 20 mil	Determined by symbol length and scan angle	23.0 in. (58.42 cm)

CHAPTER 3 USB INTERFACE

Introduction

This chapter provides instructions for programming the scanner to interface with a USB host. The scanner connects directly to a USB host, or a powered USB hub. The USB host can power the scanner.

Throughout the programming bar code menus, default values are indicated with asterisks (*).

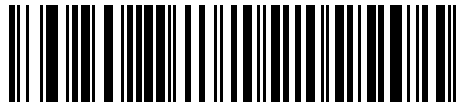

*Indicates Default — *No Delay — Feature/Option

Connecting a USB Interface

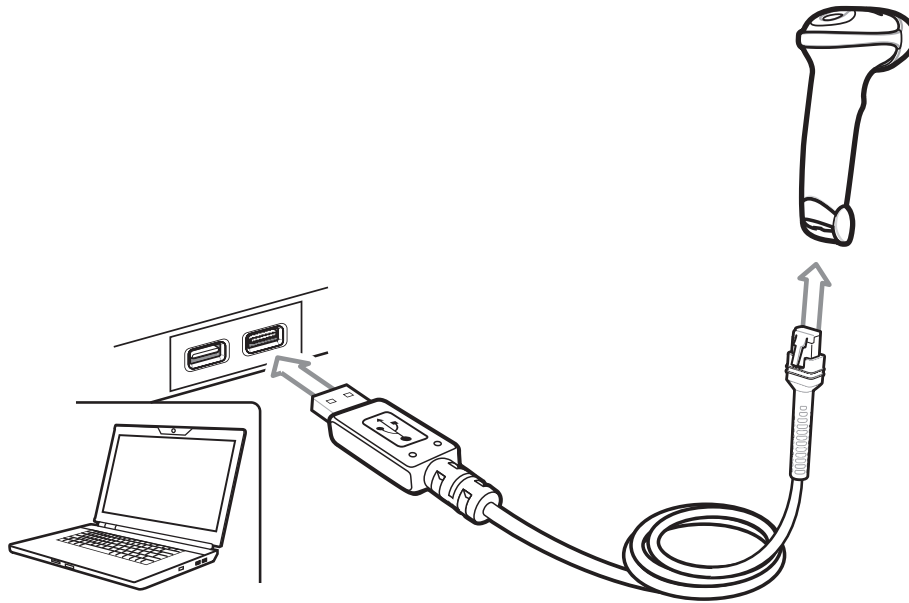

Figure 3-1 *USB Connection*

The scanner connects with USB capable hosts including:

- Desktop PCs and Notebooks
- Apple™ iMac, G4, iBooks (North America only), Macbook, Macbook Pro, Macbook Air (North American keyboard only)
- IBM SurePOS terminals
- Sun, IBM, and other network computers that support more than one keyboard.

The following operating systems support the scanner through USB:

- Windows 98, 2000, ME, XP, Vista, Windows 7 32-bit/64-bit, Windows 8
- MacOS 8.5 and above
- IBM 4690 OS.

The scanner also interfaces with other USB hosts which support USB Human Interface Devices (HID).

To connect the USB interface:

1. Attach the modular connector of the USB interface cable to the port on the bottom of the scanner, as described in [Installing the Interface Cable on page 1-3](#).
2. Plug the series A connector in the USB host or hub, or plug the Power Plus connector in an available port of the IBM SurePOS terminal.
3. Select the USB device type by scanning the appropriate bar code from [USB Device Type on page 3-5](#).

✓ **NOTE** The interface cable automatically detects the host interface type and uses the default setting. If the default (*) does not meet your requirements, scan another host bar code.

4. On first installation when using Windows, the software prompts to select or install the Human Interface Device driver. To install this driver, provided by Windows, click **Next** through all the choices and click **Finished** on the last choice. The scanner powers up during this installation.
5. To modify any other parameter options, scan the appropriate bar codes in this chapter.

If problems occur with the system, see [Troubleshooting on page 11-2](#).

USB Parameter Defaults

Table 3-1 lists the defaults for USB host parameters. If any option needs to be changed, scan the appropriate bar code(s) provided in the Parameter Descriptions section beginning on [page 3-5](#).

✓ **NOTE** See [Chapter B, COUNTRY CODES](#) for USB Country Keyboard Types (Country Codes).

See [Appendix A, STANDARD DEFAULT PARAMETERS](#) for all user preferences, hosts, symbologies, and miscellaneous default parameters.

Table 3-1 *USB Host Default Table*

Parameter	Default	Page Number
USB Host Parameters		
USB Device Type	USB Keyboard (HID)	3-5
Symbol Native API (SNAPI) Status Handshaking	Enable	3-6
USB Keystroke Delay	No Delay	3-7
USB CAPS Lock Override	Disable	3-7
USB Ignore Unknown Characters	Send	3-8
USB Convert Unknown to Code 39	Disable	3-8
Emulate Keypad	Disable	3-9
Emulate Keypad with Leading Zero	Disable	3-9
Quick Keypad Emulation	Disable	3-10
USB FN1 Substitution	Disable	3-10
Function Key Mapping	Disable	3-11
Simulated Caps Lock	Disable	3-11
Convert Case	No Case Conversion	3-12
USB Polling Interval	8 msec	3-14
Fast HID Keyboard	Disable	3-14
USB Static CDC	Enable	3-15
TGCS (IBM) USB Ignore Beep Directive	Disable	3-16
TGCS (IBM) USB Ignore Bar Code Configuration Directive	Disable	3-16

USB Host Parameters

USB Device Type

Select the desired USB device type.

- ✓ **NOTE** When changing USB device types, the scanner automatically restarts. The scanner issues a power-up beep sequence.
- ✓ **NOTE** Select **IBM Hand-Held USB** to disable data transmission when an IBM register issues a Scan Disable command. Decoding is still permitted. Select **IBM OPOS (IBM Hand-held USB with Full Scan Disable)** to completely shut off the scanner when an IBM register issues a Scan Disable command, including decoding and data transmission.
- ✓ **NOTE** Before selecting **USB CDC Host**, install the CDC INF file on the host to ensure the scanner does not stall during power up (due to a failure to enumerate USB). If the scanner stalls, to recover it:
 - 1) Install the CDC INF file
or
 - 2) After power-up, hold the trigger for 10 seconds, which allows the scanner to power up using an alternate USB configuration. Upon power-up, scan another **USB Device Type**.



*USB Keyboard (HID)



IBM Table Top USB

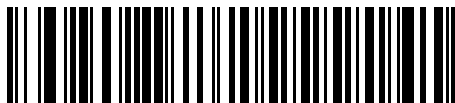

IBM Hand-Held USB



IBM OPOS
(IBM Hand-held USB with Full Scan Disable)

USB Device Type (continued)



Simple COM Port Emulation



USB CDC Host



Symbol Native API (SNAPI) without Imaging Interface

(This device type applies only to scanners branded with a silver logo)

symbol

Symbol Native API (SNAPI) Status Handshaking

After selecting a SNAPI interface as the USB device type, select whether to enable or disable status handshaking.



NOTE This parameter applies only to scanners branded with a silver logo

symbol



*Enable SNAPI Status Handshaking



Disable SNAPI Status Handshaking

USB Keystroke Delay

This parameter sets the delay, in milliseconds, between emulated keystrokes. Scan a bar code below to increase the delay when hosts require a slower transmission of data.



***No Delay**

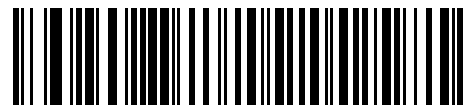

Medium Delay (20 msec)

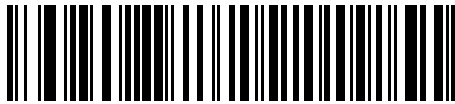

Long Delay (40 msec)

USB CAPS Lock Override

This option applies only to the USB Keyboard (HID) device. When enabled, the case of the data is preserved regardless of the state of the caps lock key. This setting is always enabled for the “Japanese, Windows (ASCII)” keyboard type and can not be disabled.

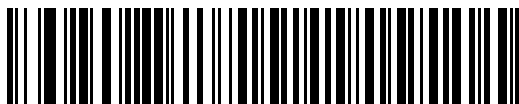

**Override Caps Lock Key
(Enable)**



***Do Not Override Caps Lock Key
(Disable)**

USB Ignore Unknown Characters

This option applies only to the USB Keyboard (HID) device and IBM device. Unknown characters are characters the host does not recognize. When **Send Bar Codes With Unknown Characters** is selected, all bar code data is sent except for unknown characters, and no error beeps sound. When **Do Not Send Bar Codes With Unknown Characters** is selected, bar code data is sent up to the first unknown character, then the scanner issues an error beep.

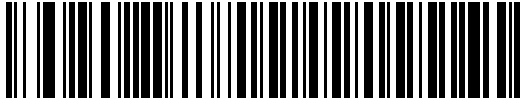

***Send Bar Codes with Unknown Characters**

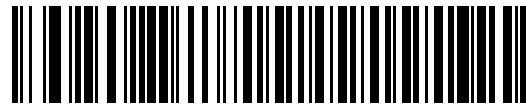

Do Not Send Bar Codes with Unknown Characters

USB Convert Unknown to Code 39

This option applies only to the IBM Handheld, IBM Tabletop, and OPOS devices. Scan a bar code below to enable or disable converting unknown bar code type data to Code 39.

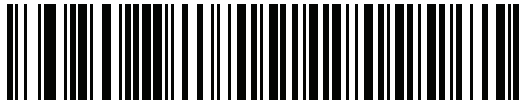

***Disable Convert Unknown to Code 39**



Enable Convert Unknown to Code 39

Emulate Keypad

When enabled, all characters are sent as ASCII sequences over the numeric keypad. For example ASCII A would be sent as “ALT make” 0 6 5 “ALT Break.”

✓ **NOTE** If your keyboard type is not listed in the country code list (see [Appendix B, COUNTRY CODES](#)), disable [Quick Keypad Emulation on page 3-10](#) and ensure **Emulate Keypad** is enabled.



***Disable Keypad Emulation**

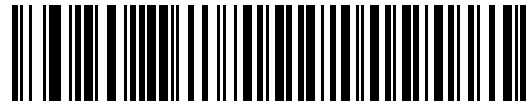

Enable Keypad Emulation

Emulate Keypad with Leading Zero

Enable this to send character sequences sent over the numeric keypad as ISO characters which have a leading zero. For example ASCII A transmits as “ALT MAKE” 0 0 6 5 “ALT BREAK”.



***Disable Keypad Emulation with Leading Zero**



Enable Keypad Emulation with Leading Zero

Quick Keypad Emulation

This option applies only to the HID Keyboard Emulation Device and if Emulate Keypad is enabled. This parameter enables a quicker method of keypad emulation where ASCII sequences are only sent for ASCII characters not found on the keyboard.

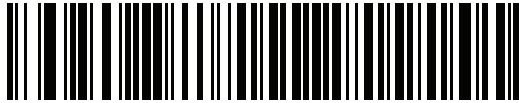

Enable

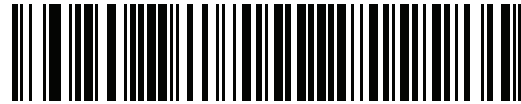

***Disable**

USB Keyboard FN1 Substitution

This option applies only to the USB Keyboard (HID) device. When enabled, this allows replacement of any FN1 characters in an EAN 128 bar code with a Key Category and value chosen by the user (see [FN1 Substitution Values on page 7-24](#) to set the Key Category and Key Value).



Enable FN1 Substitution



***Disable FN1 Substitution**

Function Key Mapping

ASCII values under 32 are normally sent as a control-key sequences (see [Table 3-2 on page 3-17](#)). When this parameter is enabled, the keys in bold are sent in place of the standard key mapping. Table entries that do not have a bold entry remain the same whether or not this parameter is enabled.

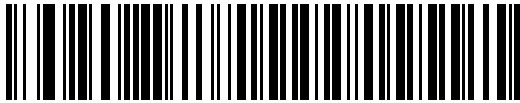

***Disable Function Key Mapping**

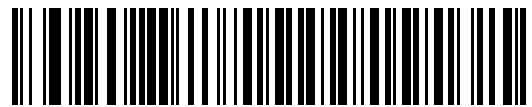

Enable Function Key Mapping

Simulated Caps Lock

When enabled, the scanner inverts upper and lower case characters on the scanner bar code as if the Caps Lock state is enabled on the keyboard. This inversion is done regardless of the current state of the keyboard's Caps Lock state.

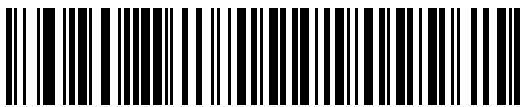

***Disable Simulated Caps Lock**

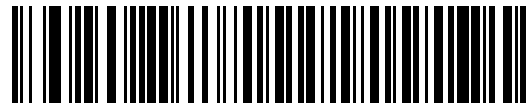

Enable Simulated Caps Lock

Convert Case

When enabled, the scanner converts all bar code data to the selected case.



***No Case Conversion**

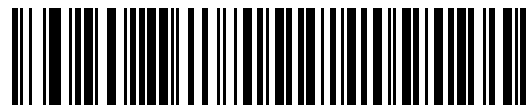

Convert All to Upper Case

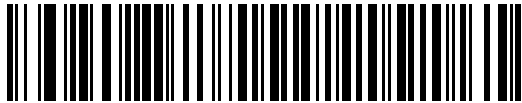

Convert All to Lower Case

USB Polling Interval

Scan a bar code below to set the polling interval. The polling interval determines the rate at which data can be sent between the scanner and host computer. A lower number indicates a faster data rate.



NOTE When changing the USB polling interval, the scanner automatically restarts and issues a power-up beep sequence.



IMPORTANT Ensure your host machine can handle the selected data rate.



1 msec



2 msec

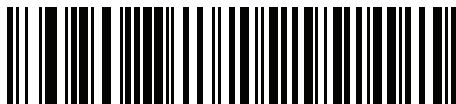

3 msec

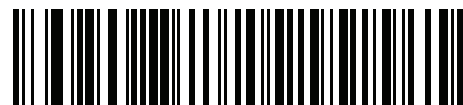

4 msec

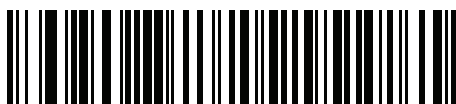

5 msec

USB Polling Interval (continued)



6 msec

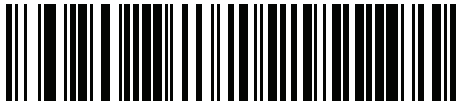

7 msec



*8 msec



9 msec

Fast HID Keyboard

This option transmits USB HID keyboard data at a faster rate.

✓ **NOTE** Enabling **Quick Keypad Emulation** (on page [3-10](#)) disables **Fast HID Keyboard**.



Enable

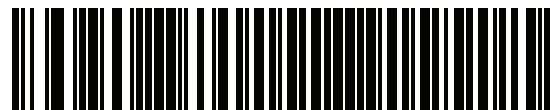

*Disable

USB Static CDC

When disabled, each device connected consumes another COM port (first device = COM1, second device = COM2, third device = COM3, etc.)

When enabled, each device connects to the same COM port.



***Enable USB Static CDC**



Disable USB Static CDC

Optional USB Parameters

If the configured settings are changed or not saved after restarting the system, scan the following bar codes to override USB interface defaults.

Scan these bar codes after setting defaults and before configuring the scanner.

TGCS (IBM) USB Ignore Beep Directive

The host can send a beep request to the scanner. When this parameter is enabled, the request is not sent to the attached scanner. All directives are still acknowledged to the USB host as if processed.



***Disable (Acknowledge Beep)**



Enable (Ignore Beep)

TGCS (IBM) USB Ignore Bar Code Configuration Directive

The host has the ability to enable/disable code types. When this parameter is enabled, the request is not sent to the attached scanner. All directives are still acknowledged to the USB host as if processed.



***Disable (Acknowledge Bar Code Configuration)**



Enable (Ignore Bar Code Configuration)

ASCII Character Set for USB

Table 3-2 ASCII Character Set for USB

ASCII Value	Full ASCII Code 39 Encode Character	Keystroke
1000	%U	CTRL 2
1001	\$A	CTRL A
1002	\$B	CTRL B
1003	\$C	CTRL C
1004	\$D	CTRL D
1005	\$E	CTRL E
1006	\$F	CTRL F
1007	\$G	CTRL G
1008	\$H	CTRL H/ BACKSPACE ¹
1009	\$I	CTRL I/ HORIZONTAL TAB ¹
1010	\$J	CTRL J
1011	\$K	CTRL K
1012	\$L	CTRL L
1013	\$M	CTRL M/ ENTER ¹
1014	\$N	CTRL N
1015	\$O	CTRL O
1016	\$P	CTRL P
1017	\$Q	CTRL Q
1018	\$R	CTRL R
1019	\$S	CTRL S
1020	\$T	CTRL T
1021	\$U	CTRL U
1022	\$V	CTRL V
1023	\$W	CTRL W
1024	\$X	CTRL X

¹The keystroke in bold is sent only if the "Function Key Mapping" is enabled. Otherwise, the non-bold keystroke is sent.

Table 3-2 ASCII Character Set for USB (Continued)

ASCII Value	Full ASCII Code 39 Encode Character	Keystroke
1025	\$Y	CTRL Y
1026	\$Z	CTRL Z
1027	%A	CTRL [/ESC ¹
1028	%B	CTRL \
1029	%C	CTRL]
1030	%D	CTRL 6
1031	%E	CTRL -
1032	Space	Space
1033	/A	!
1034	/B	“
1035	/C	#
1036	/D	\$
1037	/E	%
1038	/F	&
1039	/G	‘
1040	/H	(
1041	/I)
1042	/J	*
1043	/K	+
1044	/L	,
1045	-	-
1046	.	.
1047	/O	/
1048	0	0
1049	1	1
1050	2	2
1051	3	3
1052	4	4

¹The keystroke in bold is sent only if the “Function Key Mapping” is enabled. Otherwise, the non-bold keystroke is sent.

Table 3-2 ASCII Character Set for USB (Continued)

ASCII Value	Full ASCII Code 39 Encode Character	Keystroke
1053	5	5
1054	6	6
1055	7	7
1056	8	8
1057	9	9
1058	/Z	:
1059	%F	;
1060	%G	<
1061	%H	=
1062	%I	>
1063	%J	?
1064	%V	@
1065	A	A
1066	B	B
1067	C	C
1068	D	D
1069	E	E
1070	F	F
1071	G	G
1072	H	H
1073	I	I
1074	J	J
1075	K	K
1076	L	L
1077	M	M
1078	N	N
1079	O	O
1080	P	P
1081	Q	Q

¹The keystroke in bold is sent only if the "Function Key Mapping" is enabled. Otherwise, the non-bold keystroke is sent.

Table 3-2 ASCII Character Set for USB (Continued)

ASCII Value	Full ASCII Code 39 Encode Character	Keystroke
1082	R	R
1083	S	S
1084	T	T
1085	U	U
1086	V	V
1087	W	W
1088	X	X
1089	Y	Y
1090	Z	Z
1091	%K	[
1092	%L	\
1093	%M]
1094	%N	^
1095	%O	_
1096	%W	`
1097	+A	a
1098	+B	b
1099	+C	c
1100	+D	d
1101	+E	e
1102	+F	f
1103	+G	g
1104	+H	h
1105	+I	i
1106	+J	j
1107	+K	k
1108	+L	l
1109	+M	m
1110	+N	n

¹The keystroke in bold is sent only if the "Function Key Mapping" is enabled. Otherwise, the non-bold keystroke is sent.

Table 3-2 ASCII Character Set for USB (Continued)

ASCII Value	Full ASCII Code 39 Encode Character	Keystroke
1111	+O	o
1112	+P	p
1113	+Q	q
1114	+R	r
1115	+S	s
1116	+T	t
1117	+U	u
1118	+V	v
1119	+W	w
1120	+X	x
1121	+Y	y
1122	+Z	z
1123	%P	{
1124	%Q	
1125	%R	}
1126	%S	~

¹The keystroke in bold is sent only if the "Function Key Mapping" is enabled. Otherwise, the non-bold keystroke is sent.

Table 3-3 *USB ALT Key Character Set*

ALT Keys	Keystroke
2064	ALT 2
2065	ALT A
2066	ALT B
2067	ALT C
2068	ALT D
2069	ALT E
2070	ALT F
2071	ALT G
2072	ALT H
2073	ALT I
2074	ALT J
2075	ALT K
2076	ALT L
2077	ALT M
2078	ALT N
2079	ALT O
2080	ALT P
2081	ALT Q
2082	ALT R
2083	ALT S
2084	ALT T
2085	ALT U
2086	ALT V
2087	ALT W
2088	ALT X
2089	ALT Y
2090	ALT Z

Table 3-4 *USB GUI Key Character Set*

GUI Key	Keystroke
3000	Right Control Key
3048	GUI 0
3049	GUI 1
3050	GUI 2
3051	GUI 3
3052	GUI 4
3053	GUI 5
3054	GUI 6
3055	GUI 7
3056	GUI 8
3057	GUI 9
3065	GUI A
3066	GUI B
3067	GUI C
3068	GUI D
3069	GUI E
3070	GUI F
3071	GUI G
3072	GUI H
3073	GUI I
3074	GUI J
3075	GUI K
3076	GUI L
3077	GUI M
3078	GUI N
3079	GUI O
3080	GUI P
3081	GUI Q

Note: GUI Shift Keys - The Apple™ iMac keyboard has an apple key on either side of the space bar. Windows-based systems have a GUI key to the left of the left ALT key, and to the right of the right ALT key.

Table 3-4 USB GUI Key Character Set (Continued)

GUI Key	Keystroke
3082	GUI R
3083	GUI S
3084	GUI T
3085	GUI U
3086	GUI V
3087	GUI W
3088	GUI X
3089	GUI Y
3090	GUI Z

Note: GUI Shift Keys - The Apple™ iMac keyboard has an apple key on either side of the space bar. Windows-based systems have a GUI key to the left of the left ALT key, and to the right of the right ALT key.

Table 3-5 USB F Key Character Set

F Keys	Keystroke
5001	F1
5002	F2
5003	F3
5004	F4
5005	F5
5006	F6
5007	F7
5008	F8
5009	F9
5010	F10
5011	F11
5012	F12
5013	F13
5014	F14
5015	F15
5016	F16
5017	F17

Table 3-5 *USB F Key Character Set (Continued)*

F Keys	Keystroke
5018	F18
5019	F19
5020	F20
5021	F21
5022	F22
5023	F23
5024	F24

Table 3-6 *USB Numeric Keypad Character Set*

Numeric Keypad	Keystroke
6042	*
6043	+
6044	undefined
6045	-
6046	.
6047	/
6048	0
6049	1
6050	2
6051	3
6052	4
6053	5
6054	6
6055	7
6056	8
6057	9
6058	Enter
6059	Num Lock

Table 3-7 *USB Extended Keypad Character Set*

Extended Keypad	Keystroke
7001	Break
7002	Delete
7003	PgUp
7004	End
7005	Pg Dn
7006	Pause
7007	Scroll Lock
7008	Backspace
7009	Tab
7010	Print Screen
7011	Insert
7012	Home
7013	Enter
7014	Escape
7015	Up Arrow
7016	Down Arrow
7017	Left Arrow
7018	Right Arrow

CHAPTER 4 RS-232 INTERFACE

Introduction

This chapter provides instructions for programming the scanner to interface with an RS-232 host interface. The RS-232 interface is used to attach the scanner to point-of-sale devices, host computers, or other devices with an available RS-232 port (i.e., COM port).

If the particular host is not listed in [Table 4-2](#), set the communication parameters to match the host device. Refer to the documentation for the host device.

✓ **NOTE** This scanner uses TTL RS-232 signal levels, which interface with most system architectures. For system architectures requiring RS-232C signal levels, we offer different cables providing the TTL to RS-232C conversion. Contact support for more information.

Throughout the programming bar code menus, default values are indicated with asterisks (*).



*Indicates Default *Baud Rate 9600 — Feature/Option

Connecting an RS-232 Interface

This connection is made directly from the scanner to the host computer.

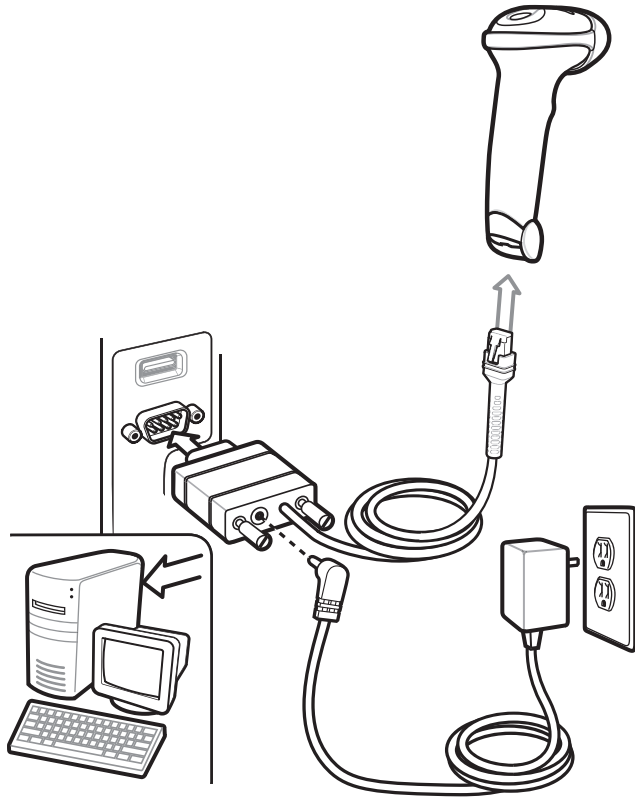

Figure 4-1 RS-232 Direct Connection

To connect the RS-232 interface:

1. Attach the modular connector of the RS-232 interface cable to the host port on the bottom of the scanner, as described in [Installing the Interface Cable on page 1-3](#).
2. Connect the other end of the RS-232 interface cable to the serial port on the host.
3. Connect the power supply to the power connector on the RS-232 interface cable. Plug the power supply into an appropriate outlet.

✓ **NOTE** The interface cable automatically detects the host interface type and uses the default setting. If the default (*) does not meet your requirements, scan another host bar code.

4. To modify any other parameter options, scan the appropriate bar codes in this chapter.

RS-232 Parameter Defaults

[Table 4-1](#) lists the defaults for RS-232 host parameters. If any option needs to be changed, scan the appropriate bar code(s) provided in the Parameter Descriptions section beginning on [page 4-4](#).

✓ **NOTE** See [Appendix A, STANDARD DEFAULT PARAMETERS](#) for all user preferences, hosts, symbologies, and miscellaneous default parameters.

Table 4-1 RS-232 Host Default Table

Parameter	Default	Page Number
RS-232 Host Parameters		
RS-232 Host Types	Standard	4-6
Baud Rate	9600	4-8
Stop Bits	1 Stop Bit	4-9
Data Bits (ASCII Format)	8-bit	4-10
Parity	None	4-11
Check Receive Errors	Enable	4-12
Hardware Handshaking	None	4-12
Software Handshaking	None	4-14
Host Serial Response Time-out	2 sec	4-16
RTS Line State	Low RTS	4-17
Beep on <BEL>	Disable	4-17
Intercharacter Delay	0 msec	4-18
Nixdorf Beep/LED Options	Normal Operation	4-19
Ignore Unknown Characters	Send Bar Code	4-19

RS-232 Host Parameters

Various RS-232 hosts are set up with their own parameter default settings (*Table 4-2*). Selecting the ICL, Fujitsu, Wincor-Nixdorf Mode A, Wincor-Nixdorf Mode B, Olivetti, Omron, or terminal sets the defaults listed below.

Table 4-2 Terminal Specific RS-232

Parameter	ICL	Fujitsu	Wincor-Nixdorf Mode A	Wincor-Nixdorf Mode B/OPOS/JPOS	Olivetti	Omron	CUTE
Transmit Code ID	Yes	Yes	Yes	Yes	Yes	Yes	Yes
Data Transmission Format	Data/Suffix	Data/Suffix	Data/Suffix	Data/Suffix	Prefix/Data/Suffix	Data/Suffix	Prefix/Data/Suffix
Prefix	None	None	None	None	STX (1003)	None	STX (1002)
Suffix	CR (1013)	CR (1013)	CR (1013)	CR (1013)	ETX (1002)	CR (1013)	CR (1013) ETX (1003)
Baud Rate	9600	9600	9600	9600	9600	9600	9600
Stop Bits	One	One	One	One	One	One	One
ASCII Format	8-bit	8-bit	8-bit	8-bit	7-bit	8-bit	7-bit
Parity	Even	None	Odd	Odd	Even	None	Even
Hardware Handshaking	RTS/CTS Option 3	None	RTS/CTS Option 3	RTS/CTS Option 3	None	None	None
Software Handshaking	None	None	None	None	ACK/NAK	None	None
Serial Response Time-out	9.9 Sec.	2 Sec.	9.9 Sec.	9.9 Sec.	9.9 Sec.	9.9 Sec.	9.9 Sec.
RTS Line State	High	Low	Low	Low = No data to send	Low	High	High
Beep On <BEL>	Disable	Disable	Disable	Disable	Disable	Disable	Disable

Notes:

In the Nixdorf Mode B, if CTS is low, scanning is disabled. When CTS is high, scanning is enabled.

If you scan Nixdorf Mode B without connecting the scanner to the proper host, it may appear unable to scan. If this happens, scan a different RS-232 host type within 5 seconds of cycling power to the scanner.

The CUTE host disables all parameter scanning, including Set Defaults. If you inadvertently select CUTE, enable *Parameter Bar Code Scanning* on page 7-7, then change the host selection.

In ASCII format, when 7-bit is selected, Parity must be set to Odd or Even. If Parity is set to None, the scanner automatically operates in 8-bit mode, even if 7-bit is scanned.

RS-232 Host Parameters (continued)

Selecting the ICL, Fujitsu, Wincor-Nixdorf Mode A, Wincor-Nixdorf Mode B, OPOS terminal enables the transmission of code ID characters listed in [Table](#) below. These code ID characters are not programmable and are separate from the Transmit Code ID feature. The Transmit Code ID feature should not be enabled for these terminals.

✓ **NOTE** The code types in [Table](#) may not be automatically enabled. Check the defaults for each code type in [Table 8-1, Chapter 8, SYMBOLOGIES](#).

Table 4-3 Terminal Specific Code ID Characters

Code Type	ICL	Fujitsu	Wincor-Nixdorf Mode A	Wincor-Nixdorf Mode B/OPOS/JPOS	Olivetti	Omron	CUTE
UPC-A	A	A	A	A	A	A	A
UPC-E	E	E	C	C	C	E	None
EAN-8/JAN-8	FF	FF	B	B	B	FF	None
EAN-13/JAN-13	F	F	A	A	A	F	A
Code 39	C <len>	None	M	M	M <len>	C <len>	3
Code 39 Full ASCII	None	None	M	M	None	None	3
Codabar	N <len>	None	N	N	N <len>	N <len>	None
Code 128	L <len>	None	K	K	K <len>	L <len>	5
I 2 of 5	I <len>	None	I	I	I <len>	I <len>	1
Code 93	None	None	L	L	L <len>	None	None
D 2 of 5	H <len>	None	H	H	H <len>	H <len>	2
GS1-128	L <len>	None	P	P	P <len>	L <len>	5
MSI	None	None	O	O	O <len>	None	None
Bookland EAN	F	F	A	A	A	F	None
Trioptic	None	None	None	None	None	None	None
Code 11	None	None	None	None	None	None	None
IATA	H<len>	None	H	H	H <len>	H <len>	2
Code 32	None	None	None	None	None	None	None
GS1 DataBar Variants	None	None	E	E	None	None	None

RS-232 Host Types

To select an RS-232 host interface, scan one of the following bar codes.



***Standard RS-232**

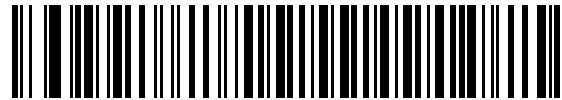

ICL RS-232

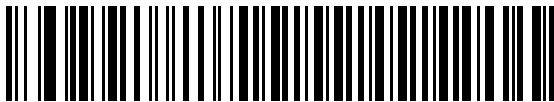

Wincor-Nixdorf RS-232 Mode A



Wincor-Nixdorf RS-232 Mode B

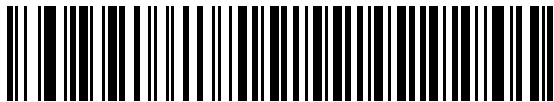

Olivetti ORS4500

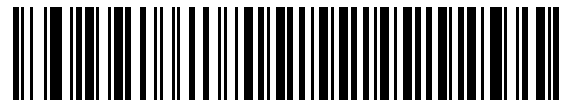

Omron



OPOS/JPOS

RS-232 Host Types (continued)

Fujitsu RS-232

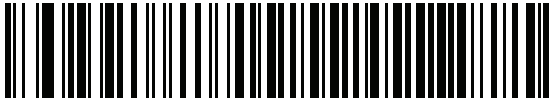

CUTE



NOTE The CUTE host applies only to scanners branded with a silver logo

symbol

The CUTE host disables all parameter scanning, including set defaults. If the CUTE parameter is inadvertently selected, enable [Parameter Bar Code Scanning on page 7-7](#), then change the host selection.

Baud Rate

Baud rate is the number of bits of data transmitted per second. Set the scanner's baud rate to match the baud rate setting of the host device. Otherwise, data may not reach the host device or may reach it in distorted form.



Baud Rate 600



Baud Rate 1200

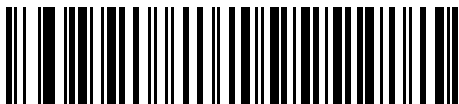

Baud Rate 2400



Baud Rate 4800

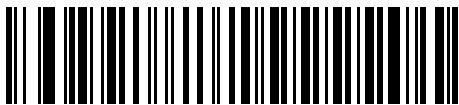

***Baud Rate 9600**

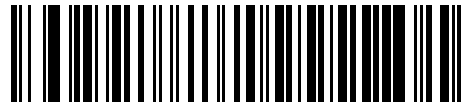

Baud Rate 19,200

Baud Rate (continued)



Baud Rate 38,400

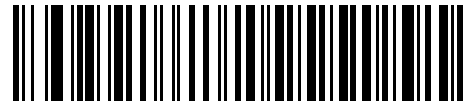

Baud Rate 57,600



Baud Rate 115,200

Stop Bits

The stop bit(s) at the end of each transmitted character marks the end of transmission of one character and prepares the receiving device for the next character in the serial data stream. The number of stop bits selected (one or two) depends on the number the receiving terminal is programmed to accommodate. Set the number of stop bits to match host device requirements.



***1 Stop Bit**

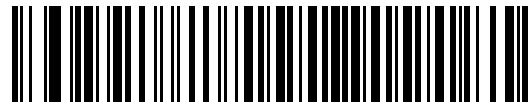

2 Stop Bits

Data Bits (ASCII Format)

This parameter allows the scanner to interface with devices requiring a 7-bit or 8-bit ASCII protocol.

- ✓ **NOTE** This parameter applies only to scanners branded with a silver logo  .
- ✓ **NOTE** When 7-bit is selected, *Parity* must be set to **Odd** or **Even**. If *Parity* is set to **None**, the scanner automatically operates in 8-bit mode, even if 7-bit is scanned.

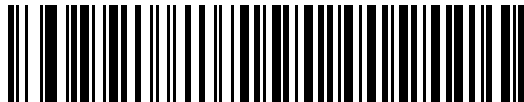

7-bit

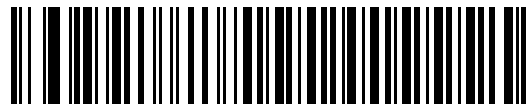

*8-bit

Parity

- ✓ **NOTE** This parameter applies only to scanners branded with a silver logo .
- ✓ **NOTE** Parity of **None** is not valid when Data Bits is set to **7-bit**.

A parity check bit is the most significant bit of each ASCII coded character. Select the parity type according to host device requirements.

- Select **Odd** parity and the parity bit value is set to 0 or 1, based on data, to ensure that an odd number of 1 bits are contained in the coded character.
- Select **Even** parity and the parity bit value is set to 0 or 1, based on data, to ensure that an even number of 1 bits are contained in the coded character.
- Select **None** when no parity bit is required.

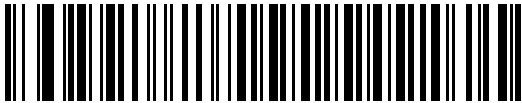

Odd



Even



*None

Check Receive Errors

Select whether to check the parity, framing, and overrun of received characters. This verifies the parity value of received characters against the parity parameter selected above.



***Check For Received Errors
(Enable)**

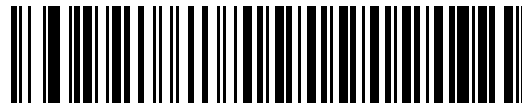

**Do Not Check For Received Errors
(Disable)**

Hardware Handshaking

The data interface consists of an RS-232 port designed to operate either with or without the hardware handshaking lines, *Request to Send* (RTS), and *Clear to Send* (CTS).

If Standard RTS/CTS handshaking is not selected, scan data is transmitted as it becomes available. If Standard RTS/CTS handshaking is selected, scan data is transmitted according to the following sequence:

- The scanner reads the CTS line for activity. If CTS is asserted, the scanner waits up to Host Serial Response Time-out for the host to de-assert the CTS line. If, after Host Serial Response Time-out, the CTS line is still asserted, the scanner sounds a transmit error, and any scanned data is lost.
- When the CTS line is de-asserted, the scanner asserts the RTS line and waits up to Host Serial Response Time-out for the host to assert CTS. When the host asserts CTS, data is transmitted. If, after Host Serial Response Time-out, the CTS line is not asserted, the scanner sounds a transmit error, and discards the data.
- When data transmission is complete, the scanner de-asserts RTS 10 msec after sending the last character.
- The host should respond by negating CTS. The scanner checks for a de-asserted CTS upon the next transmission of data.

During the transmission of data, the CTS line should be asserted. If CTS is de-asserted for more than 50 ms between characters, the transmission is aborted, the scanner sounds a transmission error, and the data is discarded.

If the above communication sequence fails, the scanner issues an error indication. In this case, the data is lost and must be rescanned.

If Hardware Handshaking and Software Handshaking are both enabled, Hardware Handshaking takes precedence.



NOTE The DTR signal is jumpered to the active state.

Hardware Handshaking (continued)

- **None:** Scan the bar code below if no Hardware Handshaking is desired.
- **Standard RTS/CTS:** Scan the bar code below to select Standard RTS/CTS Hardware Handshaking.
- **RTS/CTS Option 1:** When RTS/CTS Option 1 is selected, the scanner asserts RTS before transmitting and ignores the state of CTS. The scanner de-asserts RTS when the transmission is complete.
- **RTS/CTS Option 2:** When Option 2 is selected, RTS is always high or low (user-programmed logic level). However, the scanner waits for CTS to be asserted before transmitting data. If CTS is not asserted within Host Serial Response Time-out, the scanner issues an error indication and discards the data.
- **RTS/CTS Option 3:** When Option 3 is selected, the scanner asserts RTS prior to any data transmission, regardless of the state of CTS. The scanner waits up to Host Serial Response Time-out for CTS to be asserted. If CTS is not asserted during this time, the scanner issues an error indication and discards the data. The scanner de-asserts RTS when transmission is complete.

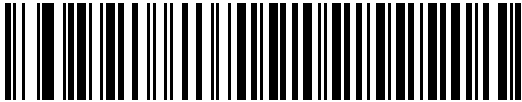

***None**



Standard RTS/CTS



RTS/CTS Option 1



RTS/CTS Option 2

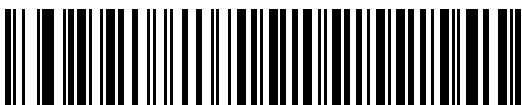

RTS/CTS Option 3

Software Handshaking

This parameter offers control of the data transmission process in addition to, or instead of, that offered by hardware handshaking. There are five options.

If Software Handshaking and Hardware Handshaking are both enabled, Hardware Handshaking takes precedence.

- **None:** When this option is selected, data is transmitted immediately. No response is expected from host.
- **ACK/NAK:** When this option is selected, after transmitting data, the scanner expects either an ACK or NAK response from the host. When a NAK is received, the scanner transmits the same data again and waits for either an ACK or NAK. After three unsuccessful attempts to send data when NAKs are received, the scanner issues an error indication and discards the data.

The scanner waits up to the programmable Host Serial Response Time-out to receive an ACK or NAK. If the scanner does not get a response in this time, it issues an error indication and discards the data. There are no retries when a time-out occurs.

- **ENQ:** When this option is selected, the scanner waits for an ENQ character from the host before transmitting data. If an ENQ is not received within the Host Serial Response Time-out, the scanner issues an error indication and discards the data. The host must transmit an ENQ character at least every Host Serial Response Time-out to prevent transmission errors.
- **ACK/NAK with ENQ:** This combines the two previous options. For re-transmissions of data, due to a NAK from the host, an additional ENQ is not required.
- **XON/XOFF:** An XOFF character turns the scanner transmission off until the scanner receives an XON character. There are two situations for XON/XOFF:
 - XOFF is received before the scanner has data to send. When the scanner has data to send, it waits up to Host Serial Response Time-out for an XON character before transmission. If the XON is not received within this time, the scanner issues an error indication and discards the data.
 - XOFF is received during a transmission. Data transmission then stops after sending the current byte. When the scanner receives an XON character, it sends the rest of the data message. The scanner waits up to 30 seconds for the XON.

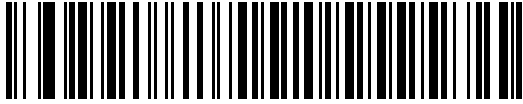
Software Handshaking (continued)

***None**

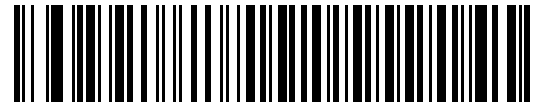

ACK/NAK

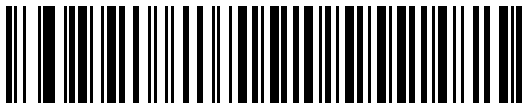

ENQ



ACK/NAK with ENQ

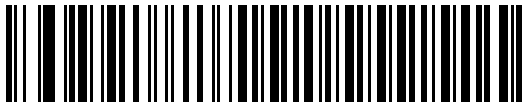

XON/XOFF

Host Serial Response Time-out

This parameter specifies how long the scanner waits for an ACK, NAK, ENQ, XON, or CTS before determining that a transmission error occurred.



***Minimum: 2 sec**



Low: 2.5 sec

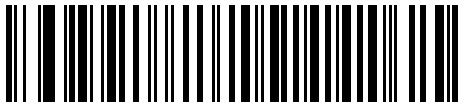

Medium: 5 sec

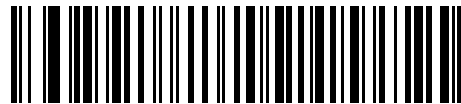

High: 7.5 sec

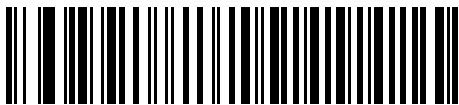

Maximum: 9.9 sec

RTS Line State

This parameter sets the idle state of the Serial Host RTS line. Scan a bar code below to select **Low RTS** or **High RTS** line state.

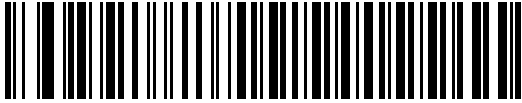

***Host: Low RTS**



Host: High RTS

Beep on <BEL>

When this parameter is enabled, the scanner issues a beep when a <BEL> character is detected on the RS-232 serial line. <BEL> is issued to gain a user's attention to an illegal entry or other important event.

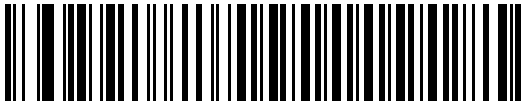

**Beep On <BEL> Character
(Enable)**



***Do Not Beep On <BEL> Character
(Disable)**

Intercharacter Delay

This parameter specifies the intercharacter delay inserted between character transmissions.

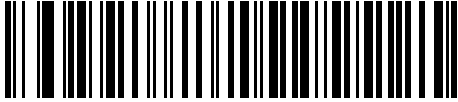

***Minimum: 0 msec**

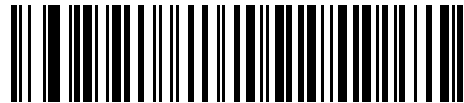

Low: 25 msec

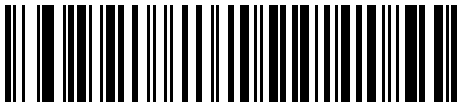

Medium: 50 msec



High: 75 msec

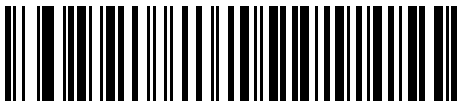

Maximum: 99 msec

Nixdorf Beep/LED Options

When Nixdorf Mode B is selected, this indicates when the scanner should beep and turn on its LED after a decode.



***Normal Operation**
(Beep/LED immediately after decode)

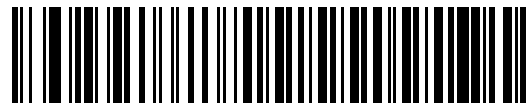

Beep/LED After Transmission



Beep/LED After CTS Pulse

Ignore Unknown Characters

Unknown characters are characters the host does not recognize. When **Send Bar Codes with Unknown Characters** is selected, all bar code data is sent except for unknown characters, and no error beeps sound on the scanner. When **Do Not Send Bar Codes With Unknown Characters** is selected, bar code data is sent up to the first unknown character and then an error beep sounds on the scanner.



***Send Bar Code with Unknown Characters**

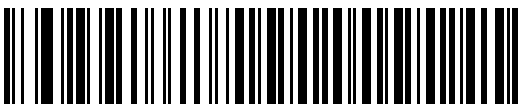

Do Not Send Bar Codes with Unknown Characters

ASCII Character Set for RS-232

The values in [Table 4-4](#) can be assigned as prefixes or suffixes for ASCII character data transmission.

Table 4-4 ASCII Character Set for RS-232

ASCII Value	Full ASCII Code 39 Encode Character	ASCII Character
1000	%U	NUL
1001	\$A	SOH
1002	\$B	STX
1003	\$C	ETX
1004	\$D	EOT
1005	\$E	ENQ
1006	\$F	ACK
1007	\$G	BELL
1008	\$H	BCKSPC
1009	\$I	HORIZ TAB
1010	\$J	LF/NW LN
1011	\$K	VT
1012	\$L	FF
1013	\$M	CR/ENTER
1014	\$N	SO
1015	\$O	SI
1016	\$P	DLE
1017	\$Q	DC1/XON
1018	\$R	DC2
1019	\$S	DC3/XOFF
1020	\$T	DC4
1021	\$U	NAK
1022	\$V	SYN
1023	\$W	ETB
1024	\$X	CAN
1025	\$Y	EM
1026	\$Z	SUB
1027	%A	ESC

Table 4-4 ASCII Character Set for RS-232 (Continued)

ASCII Value	Full ASCII Code 39 Encode Character	ASCII Character
1028	%B	FS
1029	%C	GS
1030	%D	RS
1031	%E	US
1032	Space	Space
1033	/A	!
1034	/B	"
1035	/C	#
1036	/D	\$
1037	/E	%
1038	/F	&
1039	/G	'
1040	/H	(
1041	/I)
1042	/J	*
1043	/K	+
1044	/L	,
1045	-	-
1046	.	.
1047	/O	/
1048	0	0
1049	1	1
1050	2	2
1051	3	3
1052	4	4
1053	5	5
1054	6	6
1057	7	7
1056	8	8
1057	9	9
1058	/Z	:

Table 4-4 ASCII Character Set for RS-232 (Continued)

ASCII Value	Full ASCII Code 39 Encode Character	ASCII Character
1059	%F	;
1060	%G	<
1061	%H	=
1062	%I	>
1063	%J	?
1064	%V	@
1065	A	A
1066	B	B
1067	C	C
1068	D	D
1069	E	E
1070	F	F
1071	G	G
1072	H	H
1073	I	I
1074	J	J
1075	K	K
1076	L	L
1077	M	M
1078	N	N
1079	O	O
1080	P	P
1081	Q	Q
1082	R	R
1083	S	S
1084	T	T
1085	U	U
1086	V	V
1087	W	W
1088	X	X
1089	Y	Y

Table 4-4 ASCII Character Set for RS-232 (Continued)

ASCII Value	Full ASCII Code 39 Encode Character	ASCII Character
1090	Z	Z
1091	%K	[
1092	%L	\
1093	%M]
1094	%N	^
1095	%O	_
1096	%W	`
1097	+A	a
1098	+B	b
1099	+C	c
1100	+D	d
1101	+E	e
1102	+F	f
1103	+G	g
1104	+H	h
1105	+I	i
1106	+J	j
1107	+K	k
1108	+L	l
1109	+M	m
1110	+N	n
1111	+O	o
1112	+P	p
1113	+Q	q
1114	+R	r
1115	+S	s
1116	+T	t
1117	+U	u
1118	+V	v
1119	+W	w
1120	+X	x

Table 4-4 ASCII Character Set for RS-232 (Continued)

ASCII Value	Full ASCII Code 39 Encode Character	ASCII Character
1121	+Y	y
1122	+Z	z
1123	%P	{
1124	%Q	
1125	%R	}
1126	%S	~
1127		Undefined
7013		ENTER

CHAPTER 5 IBM INTERFACE

Introduction

This chapter provides instructions for programming the scanner to interface with an IBM 468X/469X host computer.

Throughout the programming bar code menus, default values are indicated with asterisks (*).

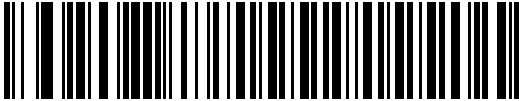

*Indicates Default — ***Disable Convert Unknown to Code 39** — Feature/Option

Connecting to an IBM 468X/469X Host

This connection is made directly from the scanner to the host interface.

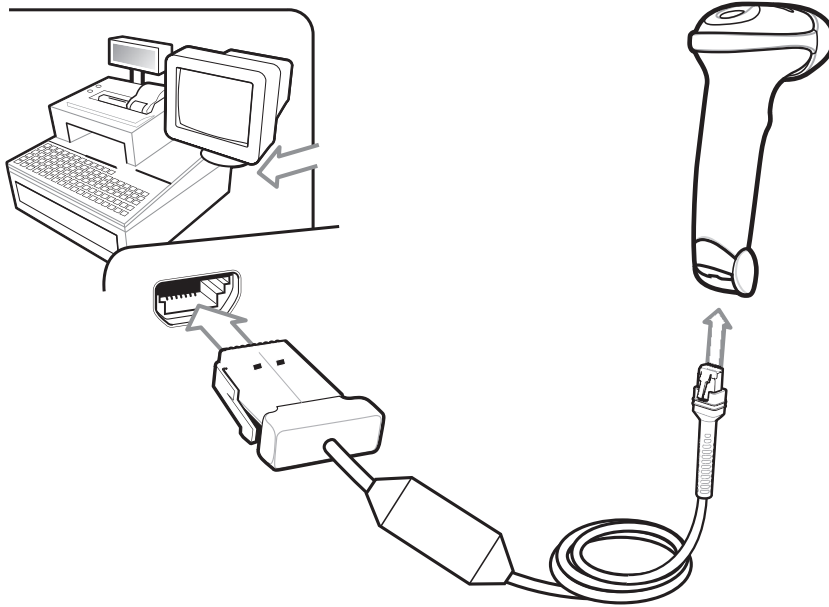



Figure 5-1 IBM Direct Connection

✓ **NOTE** *Figure 5-1* shows an auto-host detect cable. Your cable may vary.

To connect the IBM 46XX interface:

1. Attach the modular connector of the IBM 46XX interface cable to the port on the bottom of the scanner, as described in [Installing the Interface Cable on page 1-3](#).
2. Connect the other end of the IBM 46XX interface cable to the appropriate port on the host.
3. Select the port address by scanning the appropriate bar code from [Port Address on page 5-4](#).

✓ **NOTE** Scanners branded with a silver logo  **must** use auto-host detect cables, and automatically detect the host interface type, but there is no default port setting. Select a [Port Address](#) bar code to select the appropriate port.

Scanners branded with a black logo  **must** use a standard IBM cable. Select a [Port Address](#) bar code to select the appropriate port.

4. To modify any other parameter options, scan the appropriate bar codes in this chapter.

✓ **NOTE** The only required configuration is the port number. Other scanner parameters are typically controlled by the IBM system.

IBM Parameter Defaults

[Table 5-1](#) lists the defaults for IBM host parameters. To change any option, scan the appropriate bar code(s) provided in the Parameter Descriptions section beginning on [page 5-4](#).

✓ **NOTE** See [Appendix A, STANDARD DEFAULT PARAMETERS](#) for all user preferences, hosts, symbologies, and miscellaneous default parameters.

Table 5-1 *IBM Host Default Table*

Parameter	Default	Page Number
IBM 468X/469X Host Parameters		
Port Address	None Selected	5-4
Convert Unknown to Code 39	Disable	5-5
Ignore Beep	Disable	5-5
Ignore Bar Code Configuration	Disable	5-6

IBM 468X/469X Host Parameters

Port Address

This parameter sets the IBM 468X/469X port used. User selection is required to configure this interface. The auto-host detect cable feature automatically detects the host interface type, but there is no default setting. Scan one of the bar codes below to select the appropriate port.

✓ **NOTE** Scanning one of these bar codes enables the RS-485 interface on the scanner.

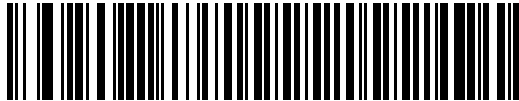

*None Selected

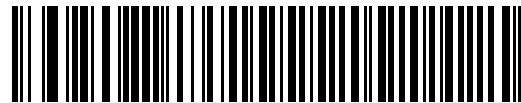

Hand-held Scanner Emulation (Port 9B)

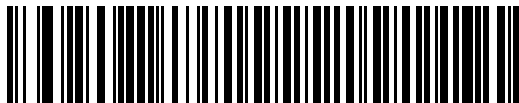

Non-IBM Scanner Emulation (Port 5B)



Table-top Scanner Emulation (Port 17)

Convert Unknown to Code 39

Scan a bar code below to enable or disable the conversion of unknown bar code type data to Code 39.



Enable Convert Unknown to Code 39

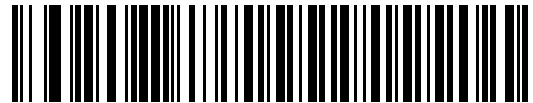

***Disable Convert Unknown to Code 39**

Optional IBM Parameters

If you configure the scanner and find the settings were not saved, or changed, when the system is restarted scan the bar codes that follow to override IBM interface defaults.

Scan a bar code below after setting defaults and before configuring the scanner.

Ignore Beep

The host can send a beep request to the scanner. When this parameter is enabled, the request is not sent to the attached scanner. All directives are still acknowledged to the IBM RS485 host as if it were processed.



***Disable (Acknowledge Beep)**



Enable (Ignore Beep)

Ignore Bar Code Configuration

The host has the ability to enable/disable code types. When this parameter is enabled, the request is not sent to the attached scanner. All directives are still acknowledged to the IBM RS485 host as if it were processed.



***Disable (Acknowledge Bar Code Configuration)**



Enable (Ignore Bar Code Configuration)

CHAPTER 6 KEYBOARD WEDGE INTERFACE

Introduction

This chapter provides instructions for programming the scanner for keyboard wedge host interface, used to connect the scanner between the keyboard and host computer. The scanner translates the bar code data into keystrokes, and transmits the information to the host computer. The host computer accepts the keystrokes as if they originated from the keyboard.

This interface adds bar code reading functionality to a system designed for manual keyboard input. In this mode the keyboard keystrokes are simply passed through.

Throughout the programming bar code menus, default values are indicated with asterisks (*).

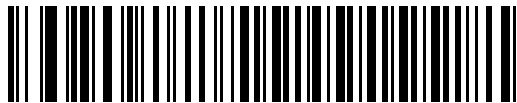

*Indicates Default *Send Bar Codes with Unknown Characters _____Feature/Option

Connecting a Keyboard Wedge Interface

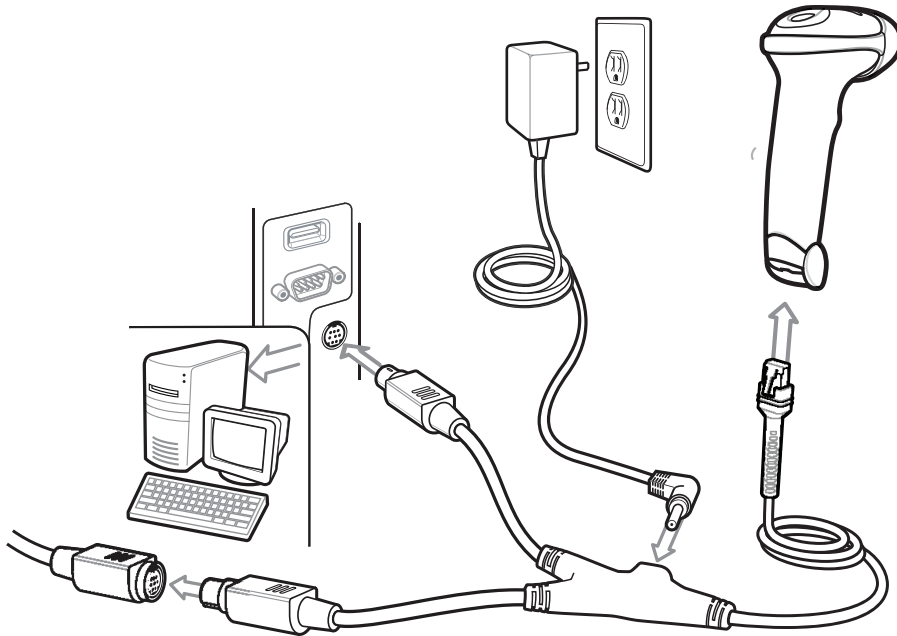



Figure 6-1 Keyboard Wedge Connection with Y-Cable

- ✓ **NOTE** Interface cables vary depending on configuration. The connectors illustrated in [Figure 6-1](#) are examples only. The connectors may be different than those illustrated, but the steps to connect the scanner remain the same.

To connect the Keyboard Wedge interface Y-cable:

1. Turn off the host and unplug the keyboard connector.
2. Attach the modular connector of the Y-cable to the cable interface port on the scanner.
3. Connect the round male DIN host connector of the Y-cable to the keyboard port on the host device.
4. Connect the round female DIN keyboard connector of the Y-cable to the keyboard connector.
5. If needed, attach the optional power supply to the connector in the middle of the Y-cable.
6. Ensure that all connections are secure.
7. Turn on the host system.
8. Select the keyboard wedge host type by scanning the appropriate bar code from [Keyboard Wedge Host Parameters on page 6-4](#).

- ✓ **NOTE** Scanners branded with a silver logo  use auto-host detect cables, and automatically detect a keyboard wedge host and use the default setting. If the default (*) does not meet your requirements, scan [IBM AT Notebook on page 6-4](#). If using a standard keyboard wedge cable, scan one of the [Keyboard Wedge Host Types on page 6-4](#).

9. To modify any other parameter options, scan the appropriate bar codes in this chapter.

Keyboard Wedge Parameter Defaults

[Table 6-1](#) lists the defaults for Keyboard Wedge host parameters. To change any option, scan the appropriate bar code(s) in [Keyboard Wedge Host Parameters on page 6-4](#).

✓ **NOTE** See [Chapter B, COUNTRY CODES](#) for Keyboard Wedge Country Keyboard Types (Country Codes).

See [Appendix A, STANDARD DEFAULT PARAMETERS](#) for all user preferences, hosts, symbologies, and miscellaneous default parameters.

Table 6-1 Keyboard Wedge Host Default Table

Parameter	Default	Page Number
Keyboard Wedge Host Parameters		
Keyboard Wedge Host Type	IBM PC/AT & IBM PC Compatible	6-4
Ignore Unknown Characters	Send	6-4
Keystroke Delay	No Delay	6-5
Intra-Keystroke Delay	Disable	6-5
Alternate Numeric Keypad Emulation	Disable	6-6
Quick Keypad Emulation	Disable	6-6
Caps Lock On	Disable	6-7
Caps Lock Override	Disable	6-7
Convert Wedge Data	No Convert	6-8
Function Key Mapping	Disable	6-8
FN1 Substitution	Disable	6-9
Send and Make Break	Send	6-9

Keyboard Wedge Host Parameters

Keyboard Wedge Host Types

Select the keyboard wedge host by scanning one of the bar codes below.



*IBM PC/AT & IBM PC Compatible

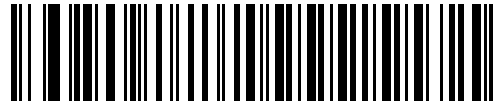

IBM AT Notebook

Ignore Unknown Characters

Unknown characters are characters the host does not recognize. When **Send Bar Codes With Unknown Characters** is selected, all bar code data is sent except for unknown characters, and no error beeps sound on the scanner. When **Do Not Send Bar Codes With Unknown Characters** is selected, bar code data is sent up to the first unknown character, then the scanner issues an error beep.



*Send Bar Codes with Unknown Characters

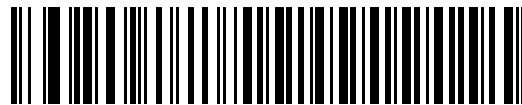

Do Not Send Bar Codes with Unknown Characters

Keystroke Delay

This is the delay in milliseconds between emulated keystrokes. Scan a bar code below to increase the delay when hosts require a slower transmission of data.



***No Delay**



Medium Delay (20 msec)

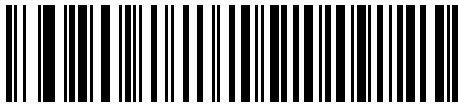

Long Delay (40 msec)

Intra-Keystroke Delay

When enabled, an additional delay is inserted between each emulated key depression and release. This sets the Keystroke Delay parameter to a minimum of 5 msec as well.



Enable Intra-Keystroke Delay

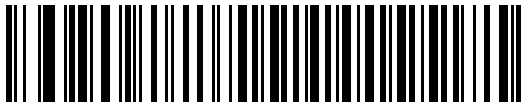

***Disable Intra-Keystroke Delay**

Alternate Numeric Keypad Emulation

In a Microsoft® operating system environment, this allows emulation of most other country keyboard types not listed in [Appendix B, COUNTRY CODES](#).

- ✓ **NOTE** If your keyboard type is not listed in the country code list (see [Appendix B, COUNTRY CODES](#)), disable [Quick Keypad Emulation on page 6-6](#) and ensure [Alternate Numeric Keypad Emulation on page 6-6](#) is enabled.



Enable Alternate Numeric Keypad

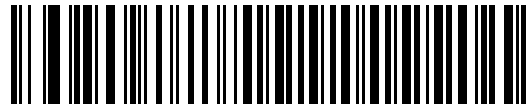

*Disable Alternate Numeric Keypad

Quick Keypad Emulation

This parameter enables a method of quicker keypad emulation where character value sequences are only sent for characters not found on the keyboard.

- ✓ **NOTE** This option applies only when **Alternate Numeric Keypad Emulation** is enabled.



Enable Quick Keypad Emulation



*Disable Quick Keypad Emulation

Caps Lock On

When enabled, the scanner emulates keystrokes as if the Caps Lock key is always pressed. Note that if both **Caps Lock On** and **Caps Lock Override** are enabled, **Caps Lock Override** takes precedence.



Enable Caps Lock On

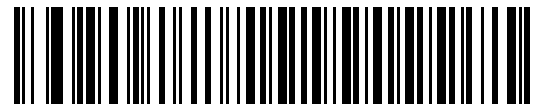

*Disable Caps Lock On

Caps Lock Override

When enabled, on AT or AT Notebook hosts, the keyboard ignores the state of the Caps Lock key. Therefore, an 'A' in the bar code is sent as an 'A' no matter what the state of the keyboard's Caps Lock key.

Note that if both **Caps Lock On** and **Caps Lock Override** are enabled, **Caps Lock Override** takes precedence.

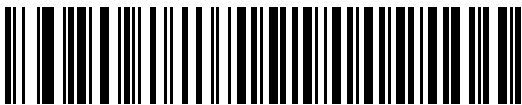

Enable Caps Lock Override



*Disable Caps Lock Override

Convert Wedge Data

When enabled, the scanner converts all bar code data to the selected case.



Convert to Upper Case

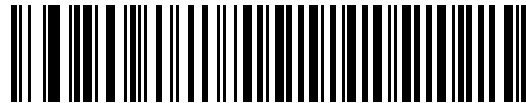

Convert to Lower Case

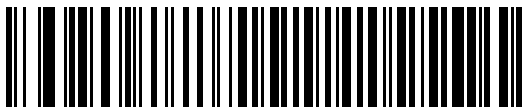

***No Convert**

Function Key Mapping

ASCII values under 32 are normally sent as control key sequences (see [Table 6-2 on page 6-11](#)). When this parameter is enabled, the keys in bold are sent in place of the standard key mapping. Table entries that do not have a bold entry remain the same whether or not this parameter is enabled.



Enable Function Key Mapping

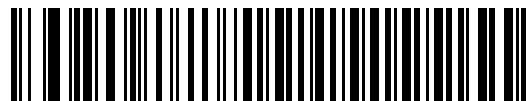

***Disable Function Key Mapping**

FN1 Substitution

When enabled, the scanner replaces FN1 characters in an EAN128 bar code with a keystroke chosen by the user (see [FN1 Substitution Values on page 7-24](#)).



Enable FN1 Substitution

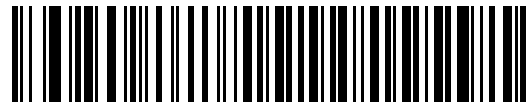

***Disable FN1 Substitution**

Send Make and Break

When enabled, the scan codes for releasing a key are not sent.

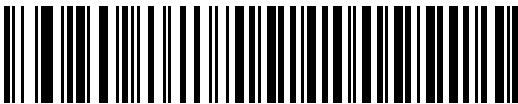

***Send Make and Break Scan Codes**

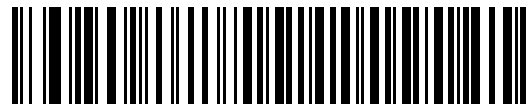

Send Make Scan Code Only

Keyboard Map

Refer to the following keyboard map for prefix/suffix keystroke parameters. To program the prefix/suffix values, see the bar codes on [page 7-21](#).

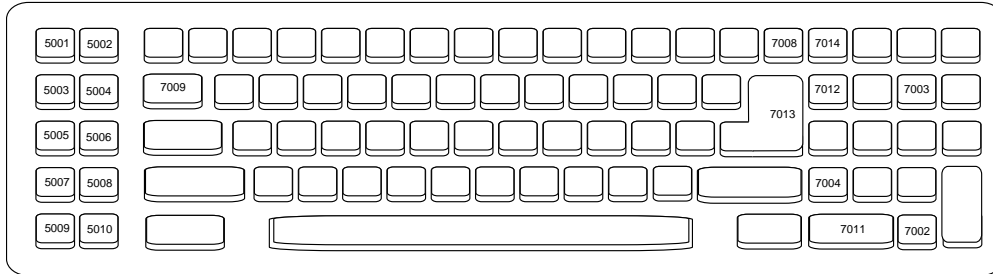

Figure 6-2 IBM PC/AT

ASCII Character Set for Keyboard Wedge

- ✓ **NOTE** Code 39 Full ASCII interprets the bar code special character (\$ + % /) preceding a Code 39 character and assigns an ASCII character value to the pair. For example, when Code 39 Full ASCII is enabled and a **+B** is scanned, it is interpreted as **b**, **%J** as **?**, and **%V** as **@**. Scanning **ABC%I** outputs the keystroke equivalent of **ABC >**.

Table 6-2 Keyboard Wedge ASCII Character Set

ASCII Value	Full ASCII Code 39 Encode Character	Keystroke
1001	\$A	CTRL A
1002	\$B	CTRL B
1003	\$C	CTRL C
1004	\$D	CTRL D
1005	\$E	CTRL E
1006	\$F	CTRL F
1007	\$G	CTRL G
1008	\$H	CTRL H/ BACKSPACE ¹
1009	\$I	CTRL I/ HORIZONTAL TAB ¹
1010	\$J	CTRL J
1011	\$K	CTRL K
1012	\$L	CTRL L
1013	\$M	CTRL M/ ENTER ¹
1014	\$N	CTRL N
1015	\$O	CTRL O
1016	\$P	CTRL P
1017	\$Q	CTRL Q
1018	\$R	CTRL R
1019	\$S	CTRL S
1020	\$T	CTRL T
1021	\$U	CTRL U
1022	\$V	CTRL V

¹The keystroke in bold is sent only if the "Function Key Mapping" is enabled. Otherwise, the non-bold keystroke is sent.

Table 6-2 Keyboard Wedge ASCII Character Set (Continued)

ASCII Value	Full ASCII Code 39 Encode Character	Keystroke
1023	\$W	CTRL W
1024	\$X	CTRL X
1025	\$Y	CTRL Y
1026	\$Z	CTRL Z
1027	%A	CTRL [/ESC ¹
1028	%B	CTRL \
1029	%C	CTRL]
1030	%D	CTRL 6
1031	%E	CTRL -
1032	Space	Space
1033	/A	!
1034	/B	"
1035	/C	#
1036	/D	\$
1037	/E	%
1038	/F	&
1039	/G	'
1040	/H	(
1041	/I)
1042	/J	*
1043	/K	+
1044	/L	,
1045	-	-
1046	.	.
1047	/O	/
1048	0	0
1049	1	1
1050	2	2
1051	3	3

¹The keystroke in bold is sent only if the "Function Key Mapping" is enabled. Otherwise, the non-bold keystroke is sent.

Table 6-2 Keyboard Wedge ASCII Character Set (Continued)

ASCII Value	Full ASCII Code 39 Encode Character	Keystroke
1052	4	4
1053	5	5
1054	6	6
1055	7	7
1056	8	8
1057	9	9
1058	/Z	:
1059	%F	;
1060	%G	<
1061	%H	=
1062	%I	>
1063	%J	?
1064	%V	@
1065	A	A
1066	B	B
1067	C	C
1068	D	D
1069	E	E
1070	F	F
1071	G	G
1072	H	H
1073	I	I
1074	J	J
1075	K	K
1076	L	L
1077	M	M
1078	N	N
1079	O	O
1080	P	P

¹The keystroke in bold is sent only if the "Function Key Mapping" is enabled. Otherwise, the non-bold keystroke is sent.

Table 6-2 Keyboard Wedge ASCII Character Set (Continued)

ASCII Value	Full ASCII Code 39 Encode Character	Keystroke
1081	Q	Q
1082	R	R
1083	S	S
1084	T	T
1085	U	U
1086	V	V
1087	W	W
1088	X	X
1089	Y	Y
1090	Z	Z
1091	%K	[
1092	%L	\
1093	%M]
1094	%N	^
1095	%O	_
1096	%W	'
1097	+A	a
1098	+B	b
1099	+C	c
1100	+D	d
1101	+E	e
1102	+F	f
1103	+G	g
1104	+H	h
1105	+I	i
1106	+J	j
1107	+K	k
1108	+L	l
1109	+M	m

¹The keystroke in bold is sent only if the "Function Key Mapping" is enabled. Otherwise, the non-bold keystroke is sent.

Table 6-2 Keyboard Wedge ASCII Character Set (Continued)

ASCII Value	Full ASCII Code 39 Encode Character	Keystroke
1110	+N	n
1111	+O	o
1112	+P	p
1113	+Q	q
1114	+R	r
1115	+S	s
1116	+T	t
1117	+U	u
1118	+V	v
1119	+W	w
1120	+X	x
1121	+Y	y
1122	+Z	z
1123	%P	{
1124	%Q	
1125	%R	}
1126	%S	~

¹The keystroke in bold is sent only if the "Function Key Mapping" is enabled. Otherwise, the non-bold keystroke is sent.

Table 6-3 *Keyboard Wedge ALT Key Character Set*

ALT Keys	Keystroke
2065	ALT A
2066	ALT B
2067	ALT C
2068	ALT D
2069	ALT E
2070	ALT F
2071	ALT G
2072	ALT H
2073	ALT I
2074	ALT J
2075	ALT K
2076	ALT L
2077	ALT M
2078	ALT N
2079	ALT O
2080	ALT P
2081	ALT Q
2082	ALT R
2083	ALT S
2084	ALT T
2085	ALT U
2086	ALT V
2087	ALT W
2088	ALT X
2089	ALT Y
2090	ALT Z

Table 6-4 *Keyboard Wedge GIU Key Character Set*

GUI Keys	Keystrokes
3000	Right Control Key
3048	GUI 0
3049	GUI 1
3050	GUI 2
3051	GUI 3
3052	GUI 4
3053	GUI 5
3054	GUI 6
3055	GUI 7
3056	GUI 8
3057	GUI 9
3065	GUI A
3066	GUI B
3067	GUI C
3068	GUI D
3069	GUI E
3070	GUI F
3071	GUI G
3072	GUI H
3073	GUI I
3074	GUI J
3075	GUI K
3076	GUI L
3077	GUI M
3078	GUI N
3079	GUI O
3080	GUI P
3081	GUI Q
3082	GUI R
3083	GUI S

Table 6-4 Keyboard Wedge GIU Key Character Set (Continued)

GUI Keys	Keystrokes
3084	GUI T
3085	GUI U
3086	GUI V
3087	GUI W
3088	GUI X
3089	GUI Y
3090	GUI Z

Table 6-5 Keyboard Wedge F Key Character Set

F Keys	Keystroke
5001	F1
5002	F2
5003	F3
5004	F4
5005	F5
5006	F6
5007	F7
5008	F8
5009	F9
5010	F10
5011	F11
5012	F12
5013	F13
5014	F14
5015	F15
5016	F16
5017	F17
5018	F18
5019	F19
5020	F20
5021	F21

Table 6-5 *Keyboard Wedge F Key Character Set (Continued)*

F Keys	Keystroke
5022	F22
5023	F23
5024	F24

Table 6-6 *Keyboard Wedge Numeric Keypad Character Set*

Numeric Keypad	Keystroke
6042	*
6043	+
6044	undefined
6045	-
6046	.
6047	/
6048	0
6049	1
6050	2
6051	3
6052	4
6053	5
6054	6
6055	7
6056	8
6057	9
6058	Enter
6059	Num Lock

Table 6-7 *Keyboard Wedge Extended Keypad Character Set*

Extended Keypad	Keystroke
7001	Break
7002	Delete
7003	Pg Up
7004	End
7005	Pg Dn
7006	Pause
7007	Scroll Lock
7008	Backspace
7009	Tab
7010	Print Screen
7011	Insert
7012	Home
7013	Enter
7014	Escape
7015	Up Arrow
7016	Dn Arrow
7017	Left Arrow
7018	Right Arrow

CHAPTER 7 USER PREFERENCES & MISCELLANEOUS SCANNER OPTIONS

Introduction

If desired, configure the scanner to perform various functions, or activate different features. This chapter describes imaging preference features and provides programming bar codes for selecting these features.

The scanner ships with the settings in [User Preferences Default Parameters on page 7-2](#) (also see [Appendix A, STANDARD DEFAULT PARAMETERS](#) for all host device and miscellaneous defaults). If the default values suit requirements, programming is not necessary.

To set feature values, scan a single bar code or a short bar code sequence. The settings are stored in non-volatile memory and are preserved even when you power down the scanner.

To return all features to default values, scan the [Set Defaults on page 7-4](#). Throughout the programming bar code menus, asterisks (*) indicate default values.



*Indicates Default — *Do Not Suppress Power Up Beeps — Feature/Option

Scanning Sequence Examples

In most cases, scanning one bar code sets the parameter value. For example, to set the beeper tone to high, scan the High Frequency (beeper tone) bar code under [Beeper Tone on page 7-9](#). The scanner issues a fast warble beep and the LED turns green, signifying a successful parameter entry.

Other parameters, such as specifying Serial Response Time-Out or setting Data Transmission Formats, require scanning several bar codes. See [Decode Session Timeout on page 7-18](#) and [Scan Data Transmission Format on page 7-22](#) for descriptions of this procedure.

Errors While Scanning

Unless otherwise specified, to correct an error during a scanning sequence, just re-scan the correct parameter.

User Preferences Default Parameters

[Table 7-1](#) lists the defaults for user preferences parameters. To change any option, scan the appropriate bar code(s) provided in the User Preferences section beginning on [page 7-4](#).

✓ **NOTE** See [Appendix A, STANDARD DEFAULT PARAMETERS](#) for all user preferences, hosts, symbologies, and miscellaneous default parameters.

Table 7-1 User Preferences Default Table

Parameter	Parameter Number	Default	Page Number
User Preferences			
Set Defaults		All Defaults	7-4
Out Of Box Experience	N/A	N/A	7-5
Report Version	N/A	N/A	7-6
Parameter Bar Code Scanning	236	Enable	7-7
Beep After Good Decode	56	Enable	7-7
Direct Decode Indicator	859	Disable	7-8
Suppress Power-up Beeps	721	Do Not Suppress	7-8
Beeper Tone	145	Medium	7-9
Beeper Volume	140	High	7-10
Beeper Duration	628	Medium	7-11
Hand-Held Trigger Mode	138	Standard (Level)	7-12
Hands-Free Trigger Mode	630	Enable	7-13
Power Mode	128	Continuous On	7-14
Time Delay to Low Power Mode	146	1 hour	7-15
Continuous Bar Code Read	649	Disable	7-17
Unique Bar Code Reporting	723	Enable	7-17
Decode Session Timeout	136	3.0 sec	7-18
Time-out Between Decodes, Same Symbol	137	0.6 sec	7-19
Time-out Between Decodes, Different Symbols	144	0.2 sec	7-19

Table 7-1 *User Preferences Default Table*

Parameter	Parameter Number	Default	Page Number
Miscellaneous Options			
Transmit Code ID Character	45	None	7-20
Prefix Value	99, 105	7013 <CR><LF>	7-21
Suffix 1 Value Suffix 2 Value	98, 104 100, 106	7013 <CR><LF>	7-21
Scan Data Transmission Format	235	Data as is	7-22
FN1 Substitution Values	103, 109	7013 <CR><LF>	7-24
Transmit "No Read" Message	94	Disable	7-25
Unsolicited Heartbeat Interval	1118	Disable	7-26
Enter Key (Carriage Return/Line Feed)	N/A	N/A	7-27
Tab Key	N/A	N/A	7-27

User Preferences

Set Defaults

The scanner can be reset to two types of defaults: factory defaults or custom defaults. Scan the appropriate bar code below to reset the scanner to its default settings and/or set the scanner's current settings as the custom default.

- **Restore Defaults** - Resets all default parameters as follows:
 - If custom default values were configured (see **Write to Custom Defaults**), the custom default values are set for all parameters each time the **Restore Defaults** bar code below is scanned.
 - If no custom default values were configured, the factory default values are set for all parameters each time the **Restore Defaults** bar code below is scanned. (For factory default values, see [Appendix A, STANDARD DEFAULT PARAMETERS](#) beginning on [page A-1.](#))
- **Set Factory Defaults** - Scan the **Set Factory Defaults** bar code below to eliminate all custom default values and set the scanner to factory default values. (For factory default values, see [Appendix A, STANDARD DEFAULT PARAMETERS](#) beginning on [page A-1.](#))
- **Write to Custom Defaults** - Custom default parameters can be configured to set unique default values for all parameters. After changing all parameters to the desired default values, scan the **Write to Custom Defaults** bar code below to configure custom defaults.



Restore Defaults



***Set Factory Defaults**



Write to Custom Defaults

Out of Box Experience

Scan the bar code below to change the Out of Box default settings to match that of the LI2208.

- ✓ **NOTE** This parameter applies only to scanners branded with a silver logo .
- ✓ **NOTE** The scanner may emit multiple power-up beeps upon scanning this bar code.



Set Out of Box Experience Defaults

[Table 7-1](#) lists the defaults that differ from the standard defaults after scanning the previous bar code.

Table 7-2 *Out of Box Experience Default Settings*

Parameter	Parameter Number	Standard Default	Out of Box Experience Default	Page Number
USB Host Parameters				
Emulate Keypad	N/A	Disable	Enable	3-9
Emulate Keypad with Leading Zero	N/A	Disable	Enable	3-9
Quick Keypad Emulation	N/A	Disable	Enable	3-10
USB Polling Interval	N/A	8 msec	3 msec	3-13
Ignore Beep	N/A	Disable	Enable	3-16
Ignore Bar Code Configuration	N/A	Disable	Enable	3-16
IBM 468X/469X Host Parameters				
Ignore Beep	N/A	Disable	Enable	5-5
Ignore Bar Code Configuration	N/A	Disable	Enable	5-6
User Preferences				
Power Mode	128	Continuous On	Reduced Power Mode	7-14
Decode Session Timeout	136	3.0 sec	9.9 sec	7-18
Time-out Between Decodes, Same Symbol	137	0.6 sec	0.5 sec	7-19
Time-out Between Decodes, Different Symbols	144	0.2 sec	0.1 sec	7-19

Table 7-2 *Out of Box Experience Default Settings*

Parameter	Parameter Number	Standard Default	Out of Box Experience Default	Page Number
Symbologies				
User-Programmable Supplementals Supplemental 1: Supplemental 2:	579 580	FFF	000	8-13
UPC/EAN/JAN Supplemental Redundancy	80	7	10	8-13
Coupon Report	730	Autodiscriminate	New Coupon Format	8-21
Set Length(s) for Code 39	18, 19	2 to 55	1 to 80	8-31
Code 93	9	Disable	Enable	8-37
Set Length(s) for Code 93	26, 27	4 to 55	1 to 80	8-37
Set Length(s) for Code 11	28, 29	4 to 55	4 to 80	8-39
Set Length(s) for I 2 of 5	22, 23	One discrete length: 14	6 to 80	8-43
Set Length(s) for D 2 of 5	20, 21	One discrete length: 12	1 to 55	8-49
Codabar	7	Disable	Enable	8-51
Set Length(s) for Codabar	24, 25	5 to 55	4 to 60	8-51
GS1 DataBar-14	338	Disable	Enable	8-64
GS1 DataBar Limited	339	Disable	Enable	8-64
GS1 DataBar Expanded	340	Disable	Enable	8-65
UPC/EAN/Code 93 Security Level	77	0	1	8-71

Report Version

Scan the bar code below to report the version of software installed in the scanner.



Report Software Version

Parameter Bar Code Scanning

Parameter # 236

To disable the decoding of parameter bar codes, including the **Set Defaults** parameter bar codes, scan the **Disable Parameter Scanning** bar code below. To enable decoding of parameter bar codes, scan **Enable Parameter Scanning**.



*Enable Parameter Bar Code Scanning
(1)



Disable Parameter Bar Code Scanning
(0)

Beep After Good Decode

Parameter # 56

Scan a bar code below to select whether or not the scanner beeps after a good decode. If selecting **Do Not Beep After Good Decode**, the beeper still operates during parameter menu scanning and to indicate error conditions.



*Beep After Good Decode
(Enable)
(1)

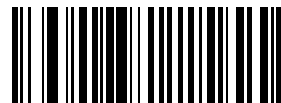

Do Not Beep After Good Decode
(Disable)
(0)

Direct Decode Indicator

Parameter # 859

Scan a bar code below to select optional blinking of the laser line upon a successful decode **if you continue to hold the trigger**. If you release the trigger upon decode, the blinking does not occur, or partial blinks may occur. This allows you to choose additional feedback for a successful decode by holding the trigger, or to continue to scan as normal.

✓ **NOTE** This parameter applies only to scanners branded with a silver logo , and only when the scanner is in *Level Trigger Mode*.



*Disable Direct Decode Indicator
(0)



1 Blink
(1)



2 Blinks
(2)

Suppress Power-up Beeps

Parameter # 721

Select whether or not to suppress the scanner's power-up beeps.

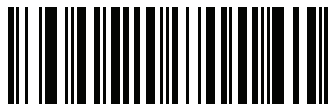

Suppress Power-up Beeps
(1)



*Do Not Suppress Power-up Beeps
(0)

Beeper Tone

Parameter # 145

To select a decode beep frequency (tone), scan one of the following bar codes.

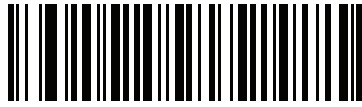

Off
(3)

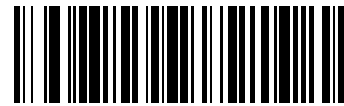

Low Tone
(2)

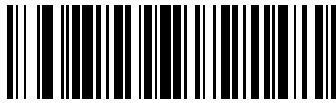

*Medium Tone
(1)

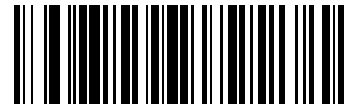

High Tone
(0)

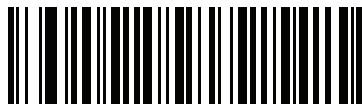

Medium to High Tone (2-tone)
(4)

Beeper Volume

Parameter # 140

To select a beeper volume, scan the **Low Volume**, **Medium Volume**, or **High Volume** bar code.



Low Volume
(2)



Medium Volume
(1)



***High Volume**
(0)

Beeper Duration

Parameter # 628

To select the duration for the beeper, scan one of the following bar codes.

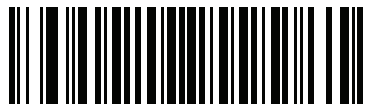

Short
(0)



*** Medium**
(1)

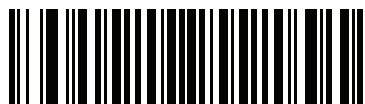

Long
(2)

Hand-Held Trigger Mode

Parameter # 138

Select one of the following trigger modes for the scanner.

- **Standard (Level)** - A trigger pull activates decode processing. Decode processing continues until the bar code decodes, you release the trigger, or the [Decode Session Timeout on page 7-18](#) occurs.
- **Presentation (Blink)** - The scanner activates decode processing when it detects a bar code. Upon entering this mode, the scan line is solid and at full length. After 3 minutes of inactivity, the scan line shortens, and after an hour, blinks. When decode processing is active, the scan line is always solid and at full length.

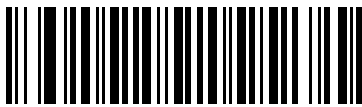

*Level (Standard)
(0)



Presentation (Blink)
(7)

Hands-Free Trigger Mode

Parameter # 630

When the scanner is seated in the Intellistand, presentation trigger mode is automatically enabled. When removed from the Intellistand, the scanner behaves according to the setting of *Hand-Held Trigger Mode on page 7-12*.

If **Hands-Free (Presentation) Trigger Mode** is enabled, the scanner automatically triggers when presented with a bar code.

✓ **NOTE** The scanner can be configured to be hand-held presentation mode, without Intellistand.

If you select **Disable Hands-Free (Presentation) Trigger Mode**, the scanner behaves according to the setting of *Hand-Held Trigger Mode on page 7-12* regardless of whether it is hand-held or in the intellistand.



*Enable Hands-Free (Presentation) Trigger Mode
(1)



Disable Hands-Free (Presentation) Trigger Mode
(0)

Power Mode

Parameter # 128

This parameter determines whether or not power remains on after a decode attempt. When in reduced power mode, the scanner enters into a low power consumption mode after each decode attempt. When in continuous power mode, power is not reduced after each decode attempt.

✓ **NOTE** This parameter applies only to scanners branded with a silver logo .



***Continuous On**
(0)



Reduced Power Mode
(1)

Time Delay to Low Power Mode

Parameter # 146

In **Low Power** mode, this parameter sets the time the scanner remains active before entering **Low Power** mode. The scanner wakes upon trigger pull or when the host attempts to communicate with the scanner.

✓ **NOTE** This parameter applies only to scanners branded with a silver logo .



1 Second
(17)



10 Seconds
(26)



1 Minute
(33)



5 Minutes
(37)



15 Minutes
(43)

Time Delay to Low Power Mode (continued)

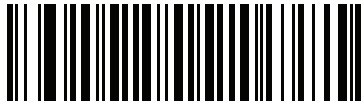

**30 Minutes
(45)**



**45 Minutes
(46)**



***1 Hour
(49)**



**3 Hours
(51)**



**6 Hours
(54)**

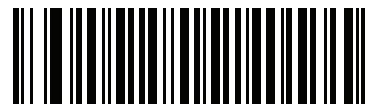

**9 Hours
(57)**

Continuous Bar Code Read

Parameter # 649

In **Standard (Level)** trigger mode, enable this to report every bar code while the trigger is pressed.



***Disable Continuous Bar Code Read
(0)**

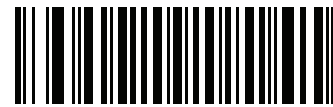

**Enable Continuous Bar Code Read
(1)**

Unique Bar Code Reporting

Parameter # 723

Enable this to report only unique bar codes while the trigger is pressed. This option only applies when **Continuous Bar Code Read** is enabled.



**Disable Unique Bar Code Reporting
(0)**



***Enable Unique Bar Code Reporting
(1)**

Decode Session Timeout

Parameter # 136

This parameter sets the maximum time decode processing continues during a scan attempt. It is programmable in 0.1 second increments from 0.5 to 9.9 seconds.

To set a Decode Session Timeout, scan the bar code below. Next scan two bar codes from [Appendix E, NUMERIC BAR CODES](#) that correspond to the desired on time. Include a leading zero for single digit numbers. For example, to set a timeout of 0.5 seconds, scan the bar code below, then scan the **0** and **5** bar codes; to set a timeout of 9.5 seconds, scan the bar code below, then scan the **9** and **5** bar codes. To change the selection or cancel an incorrect entry, scan [Cancel on page E-3](#).



Decode Session Timeout
(Default: 3.0 sec)

Timeout Between Decodes, Same Symbol

Parameter # 137

This parameter sets the minimum time between decodes of the same symbol. Use this to prevent the beeper from continuously beeping when a symbol is left in the scanner's field of view. The bar code must be out of the field of view for the timeout period before the scanner reads the same consecutive symbol. It is programmable in 0.1 second increments from 0.0 to 9.9 seconds. The default interval is 0.6 seconds.

To select the timeout between decodes for the same symbol, scan the bar code below, then scan two numeric bar codes from [Appendix E, NUMERIC BAR CODES](#) that correspond to the desired interval, in 0.1 second increments. Include a leading zero for single digit numbers. For example, to set a timeout of 0.5 seconds, scan the bar code below, then scan the "0" and "5" bar codes. If an error occurs, or to change the selection, scan **Cancel** on [page E-3](#).



Timeout Between Decodes, Same Symbol

Timeout Between Decodes, Different Symbols

Parameter # 144

This parameter sets the minimum time between decodes of different symbols, in order to control the time the scanner is inactive between decoding different symbols. It is programmable in 0.1 second increments from 0.0 to 9.9 seconds. The default is 0.2 seconds.

To select the timeout between decodes for different symbols, scan the bar code below, then scan two numeric bar codes from [Appendix E, NUMERIC BAR CODES](#) that correspond to the desired interval, in 0.1 second increments. Include a leading zero for single digit numbers. For example, to set a timeout of 0.5 seconds, scan the bar code below, then scan the "0" and "5" bar codes. If an error occurs, or to change the selection, scan **Cancel** on [page E-3](#).



Timeout Between Decodes, Different Symbols

Miscellaneous Scanner Parameters

Transmit Code ID Character

Parameter # 45

A Code ID character identifies the code type of a scanned bar code. This is useful when decoding more than one code type. In addition to any single character prefix already selected, the Code ID character is inserted between the prefix and the decoded symbol.

Select no Code ID character, a Symbol Code ID character, or an AIM Code ID character. For Code ID Characters, see [Symbol Code Identifiers on page C-1](#) and [AIM Code Identifiers on page C-2](#).

✓ **NOTE** If you enable Symbol Code ID Character or AIM Code ID Character, and enable [Transmit "No Read" Message on page 7-25](#), the scanner appends the code ID for Code 39 to the NR message.

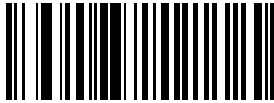

Symbol Code ID Character
(2)

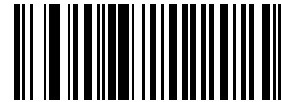

AIM Code ID Character
(1)

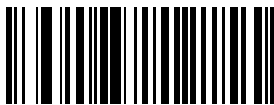

*None
(0)

Prefix/Suffix Values

Key Category Parameter # P = 99, S1 = 98, S2 = 100

Decimal Value Parameter # P = 105, S1 = 104, S2 = 106

You can append a prefix and/or one or two suffixes to scan data for use in data editing.

✓ **NOTE** To use prefix/suffix values, first set the [Scan Data Transmission Format on page 7-22](#).

To set a value for a prefix or suffix, scan a four-digit number (i.e., four bar codes from [Appendix E, NUMERIC BAR CODES](#)) that corresponds to that value. See [Table G-1 on page G-1](#) for the four-digit codes.

When using host commands to set the prefix or suffix, set the key category parameter to 1, then set the 3-digit decimal value. See [Table G-1 on page G-1](#) for the four-digit codes.

To correct an error or change a selection, scan [Cancel on page E-3](#).

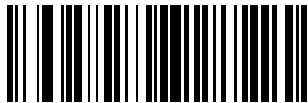

**Scan Prefix
(7)**



**Scan Suffix 1
(6)**



**Scan Suffix 2
(8)**

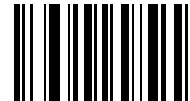

Data Format Cancel

Scan Data Transmission Format

Parameter # 235

To change the scan data format, scan one of the eight bar codes corresponding to the desired format (bar codes begin on page 7-23). To set the values for a prefix or suffix follow the instructions in [Prefix/Suffix Values on page 7-21](#).

✓ **NOTE** If using this parameter do not use ADF rules to set the prefix/suffix.

Table 7-3 Scan Data Format Descriptions

Scan Data Format	Description
Data As Is	Sends data to the host as is (with no format changes).
<DATA> <SUFFIX 1>	Sends scanned data to the host with one suffix value appended to the end of the scanned data. The suffix 1 value is set in Prefix/Suffix Values on page 7-21 .
<DATA> <SUFFIX 2>	Sends scanned data to the host with one suffix value appended to the end of the scanned data. The suffix 2 value is set in Prefix/Suffix Values on page 7-21 . Note: Suffix 1 (above) and Suffix 2, used individually as single appendages to the end of the scanned data, are virtually performing the same function - appending one suffix to the end of scanned data transmitted to the host.
<DATA> <SUFFIX 1> <SUFFIX 2>	Sends scanned data to the host with two suffix values appended to the end of the scanned data. The values for each suffix are set in Prefix/Suffix Values on page 7-21 .
<PREFIX> <DATA >	Sends scanned data to the host with one prefix value appended to the front of the scanned data. The prefix value is set in Prefix/Suffix Values on page 7-21 .
<PREFIX> <DATA> <SUFFIX 1>	Sends scanned data to the host with one prefix value appended to the front of the scanned data, and one suffix value appended to the end of the scanned data. Both prefix and suffix values are set in Prefix/Suffix Values on page 7-21 .
<PREFIX> <DATA> <SUFFIX 2>	Sends scanned data to the host with one prefix value appended to the front of the scanned data, and one suffix value appended to the end of the scanned data. Both prefix and suffix values are set in Prefix/Suffix Values on page 7-21 . Note: Suffix 1 and Suffix 2, used individually as single appendages to the end of the scanned data, are virtually performing the same function - appending one suffix to the end of scanned data transmitted to the host.
<PREFIX> <DATA> <SUFFIX 1> <SUFFIX 2>	Sends scanned data to the host with one prefix value appended to the front of the scanned data, and two suffix values appended to the end of the scanned data, in the order shown: suffix 1 followed by suffix 2. Both prefix and suffix values are set in Prefix/Suffix Values on page 7-21 .

Scan Data Transmission Format (continued)

To set values for the prefix and/or suffix, see [Prefix/Suffix Values on page 7-21](#).



***Data As Is
(0)**



**<DATA> <SUFFIX 1>
(1)**



**<DATA> <SUFFIX 2>
(2)**



**<DATA> <SUFFIX 1> <SUFFIX 2>
(3)**



**<PREFIX> <DATA >
(4)**



**<PREFIX> <DATA> <SUFFIX 1>
(5)**

Scan Data Transmission Format (continued)

<PREFIX> <DATA> <SUFFIX 2>
(6)



<PREFIX> <DATA> <SUFFIX 1> <SUFFIX 2>
(7)

FN1 Substitution Values**Key Category Parameter # 103****Decimal Value Parameter # 109**

Keyboard wedge and USB HID keyboard hosts support a FN1 Substitution feature. Enabling this substitutes any FN1 character (0x1b) in an EAN128 bar code with a value. This value defaults to 7013 (Enter key).

When using host commands to set the FN1 substitution value, set the key category parameter to 1, then set the 3-digit keystroke value. See the ASCII Character Set table for the current host interface for the desired value.

To select a FN1 substitution value via bar code menus:

1. Scan the bar code below.

**Set FN1 Substitution Value**

2. Locate the keystroke desired for FN1 Substitution in the ASCII Character Set table for the current host interface. Enter the 4-digit ASCII Value by scanning each digit in [Appendix E, NUMERIC BAR CODES](#).

To correct an error or change the selection, scan **Cancel**.

To enable FN1 substitution for USB HID keyboard, scan the **Enable FN1 Substitution** bar code on page [3-10](#).

To enable FN1 Substitution for Wedge, scan the **Enable Keyboard Wedge FN1 Substitution** bar code on page [6-9](#).

Transmit "No Read" Message

Parameter # 94

Scan a bar code below to select whether or not to transmit a No Read message. Enable this to transmit the characters NR when a successful decode does not occur before trigger release or the **Decode Session Timeout** expires. See [Decode Session Timeout on page 7-18](#). Disable this to send nothing to the host if a symbol does not decode.



NOTE If you enable **Transmit No Read**, and also enable Symbol Code ID Character or AIM Code ID Character for [Transmit Code ID Character on page 7-20](#), the scanner appends the code ID for Code 39 to the NR message.



Enable No Read
(1)



***Disable No Read**
(0)

Unsolicited Heartbeat Interval

Parameter # 1118

The scanner supports sending *Unsolicited Heartbeat Messages* to assist in diagnostics. To enable this feature and set the desired unsolicited heartbeat interval, scan one of the time interval bar codes below, or scan **Set Another Interval** followed by four numeric bar codes from [Appendix E, NUMERIC BAR CODES](#) (scan sequential numbers that correspond to the desired number of seconds).

Scan **Disable Unsolicited Heartbeat Interval** to turn off the feature.

The heartbeat event is sent as decode data (with no decode beep) in the form of:

MOTEVTHB:nnn

where *nnn* is a three-digit sequence number starting at 001 and wrapping after 100.

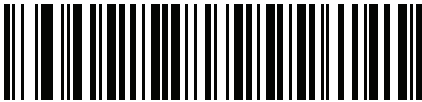

10 seconds
(10)



1 minute
(60)



Set Another Interval



***Disable Unsolicited Heartbeat Interval**
(0)

Enter Key (Carriage Return/Line Feed)

Scan the bar code below to add an Enter key after scanned data.



**Enter Key
(Carriage Return/Line Feed)**

Tab Key

Scan the bar code below to add a Tab key after scanned data.



Tab Key

CHAPTER 8 SYMBOLOGIES

Introduction

This chapter describes symbology features and provides programming bar codes for selecting these features. Before programming, follow the instructions in [Chapter 1, GETTING STARTED](#).

To set feature values, scan a single bar code or a short bar code sequence. The settings are stored in non-volatile memory and are preserved even when the scanner powers down.

To return all features to default values, scan the [Set Defaults on page 7-4](#). Throughout the programming bar code menus, asterisks (*) indicate default values.

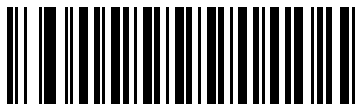

*Indicates Default — *Enable UPC-A — Feature/Option
(1) — Option Value

Scanning Sequence Examples

In most cases, scanning one bar code sets the parameter value. For example, to transmit bar code data without the UPC-A check digit, simply scan the **Do Not Transmit UPC-A Check Digit** bar code under [Transmit UPC-A Check Digit on page 8-15](#). The scanner issues a fast warble beep and the LED turns green, signifying a successful parameter entry.

Other parameters, such as **Set Length(s) for D 2 of 5** require scanning several bar codes. See the individual parameter, such as **Set Length(s) for D 2 of 5**, for this procedure.

Errors While Scanning

Unless otherwise specified, to correct an error during a scanning sequence, just re-scan the correct parameter.

Symbology Parameter Defaults

[Table 8-1](#) lists the defaults for all symbologies parameters. To change the default values, scan the appropriate bar codes in this guide. These new values replace the standard default values in memory. To recall the default parameter values, scan the [Set Defaults on page 7-4](#).

✓ **NOTE** See [Appendix A, STANDARD DEFAULT PARAMETERS](#) for all user preferences, hosts, and miscellaneous default parameters.

Table 8-1 *Parameter Defaults*

Parameter	Parameter Number	Default	Page Number
Disable/Enable All Code Types	N/A	N/A	8-6
UPC/EAN			
UPC-A	1	Enable	8-7
UPC-E	2	Enable	8-7
UPC-E1	12	Disable	8-8
EAN-8/JAN 8	4	Enable	8-8
EAN-13/JAN 13	3	Enable	8-9
Bookland EAN	83	Disable	8-9
Decode UPC/EAN/JAN Supplementals (2 and 5 digits)	16	Ignore	8-10
User-Programmable Supplementals		FFF	8-13
Supplemental 1:	579		
Supplemental 2:	580		
UPC/EAN/JAN Supplemental Redundancy	80	7	8-13
UPC/EAN/JAN Supplemental AIM ID Format	672	Combined	8-14
Transmit UPC-A Check Digit	40	Enable	8-15
Transmit UPC-E Check Digit	41	Enable	8-15
Transmit UPC-E1 Check Digit	42	Enable	8-16
UPC-A Preamble	34	System Character	8-16
UPC-E Preamble	35	System Character	8-17
UPC-E1 Preamble	36	System Character	8-18
Convert UPC-E to A	37	Disable	8-19
Convert UPC-E1 to A	38	Disable	8-19
EAN-8/JAN-8 Extend	39	Disable	8-20
Bookland ISBN Format	576	ISBN-10	8-20

Table 8-1 *Parameter Defaults (Continued)*

Parameter	Parameter Number	Default	Page Number
UCC Coupon Extended Code	85	Disable	8-21
Coupon Report	730	Autodiscriminate	8-21
ISSN EAN	617	Disable	8-22
Code 128			
Code 128	8	Enable	8-23
Set Length(s) for Code 128	209, 210	1 to 80	8-23
GS1-128 (formerly UCC/EAN-128)	14	Enable	8-25
ISBT 128	84	Enable	8-25
ISBT Concatenation	577	Autodiscriminate	8-26
Check ISBT Table	578	Enable	8-27
ISBT Concatenation Redundancy	223	10	8-27
Code 128 Security Level	751	Security Level 1	8-28
Code 39			
Code 39	0	Enable	8-29
Trioptic Code 39	13	Disable	8-29
Convert Code 39 to Code 32 (Italian Pharmacy Code)	86	Disable	8-30
Code 32 Prefix	231	Disable	8-30
Set Length(s) for Code 39	18, 19	2 to 55	8-31
Code 39 Check Digit Verification	48	Disable	8-32
Transmit Code 39 Check Digit	43	Disable	8-32
Code 39 Full ASCII Conversion	17	Disable	8-33
Buffer Code 39	113	Disable	8-34
Code 39 Security Level	750	Security Level 1	8-36
Code 93			
Code 93	9	Disable	8-37
Set Length(s) for Code 93	26, 27	4 to 55	8-37
Code 11			
Code 11	10	Disable	8-39
Set Length(s) for Code 11	28, 29	4 to 55	8-39
Code 11 Check Digit Verification	52	Disable	8-41
Transmit Code 11 Check Digit(s)	47	Disable	8-42

Table 8-1 Parameter Defaults (Continued)

Parameter	Parameter Number	Default	Page Number
Interleaved 2 of 5 (ITF)			
Interleaved 2 of 5 (ITF)	6	Enable	8-43
Set Length(s) for I 2 of 5	22, 23	One discrete length: 14	8-43
I 2 of 5 Check Digit Verification	49	Disable	8-45
Transmit I 2 of 5 Check Digit	44	Disable	8-45
Convert I 2 of 5 to EAN 13	82	Disable	8-46
I 2 of 5 Security Level	1121	1	8-47
Discrete 2 of 5 (DTF)			
Discrete 2 of 5	5	Disable	8-49
Set Length(s) for D 2 of 5	20, 21	One discrete length: 12	8-49
Codabar (NW - 7)			
Codabar	7	Disable	8-51
Set Length(s) for Codabar	24, 25	5 to 55	8-51
CLSI Editing	54	Disable	8-53
NOTIS Editing	55	Disable	8-53
Codabar Upper or Lower Case Start/Stop Characters Transmission	855	Upper Case	8-54
MSI			
MSI	11	Disable	8-55
Set Length(s) for MSI	30, 31	4 to 55	8-55
MSI Check Digits	50	1	8-57
Transmit MSI Check Digit	46	Disable	8-57
MSI Check Digit Algorithm	51	Mod 10/Mod 10	8-58
Chinese 2 of 5			
Chinese 2 of 5	408	Disable	8-59
Matrix 2 of 5			
Matrix 2 of 5	618	Disable	8-60
Matrix 2 of 5 Lengths	619, 620	4 to 80	8-60
Matrix 2 of 5 Check Digit	622	Disable	8-62
Transmit Matrix 2 of 5 Check Digit	623	Disable	8-62

Table 8-1 *Parameter Defaults (Continued)*

Parameter	Parameter Number	Default	Page Number
Korean 3 of 5			
Korean 3 of 5	581	Disable	8-63
GS1 DataBar			
GS1 DataBar-14	338	Disable	8-64
GS1 DataBar Limited	339	Disable	8-64
GS1 DataBar Expanded	340	Disable	8-65
GS1 DataBar Limited Security Level	728	Level 3	8-65
Convert GS1 DataBar to UPC/EAN	397	Disable	8-67
Symbology-Specific Security Levels			
Redundancy Level (Linear Code Type Security Level)	78	1	8-68
Bi-directional Redundancy	67	Disable	8-70
Security Level	77	0	8-71
Intercharacter Gap Size	381	Normal	8-72

Disable/Enable All Code Types

✓ **NOTE** This parameter applies only to scanners branded with a silver logo .

To disable all symbologies, scan **Disable All Code Types** below. This is useful when enabling only a few code types.

Scan **Enable All Code Types** to turn on (enable) all code types. This is useful when you want to read all codes, or when you want to disable only a few select codes.

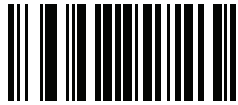

Disable All Code Types

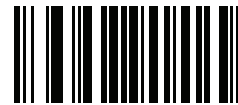

Enable All Code Types

UPC/EAN

Enable/Disable UPC-A

Parameter # 1

To enable or disable UPC-A, scan the appropriate bar code below.

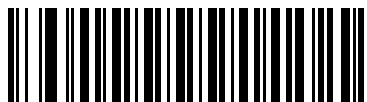

***Enable UPC-A
(1)**

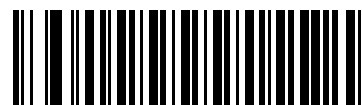

**Disable UPC-A
(0)**

Enable/Disable UPC-E

Parameter # 2

To enable or disable UPC-E, scan the appropriate bar code below.



***Enable UPC-E
(1)**



**Disable UPC-E
(0)**

Enable/Disable UPC-E1

Parameter # 12

UPC-E1 is disabled by default.

To enable or disable UPC-E1, scan the appropriate bar code below.

✓ **NOTE** UPC-E1 is not a UCC (Uniform Code Council) approved symbology.

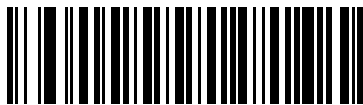

Enable UPC-E1
(1)



*Disable UPC-E1
(0)

Enable/Disable EAN-8/JAN-8

Parameter # 4

To enable or disable EAN-8/JAN-8, scan the appropriate bar code below.

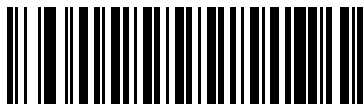

*Enable EAN-8/JAN-8
(1)



Disable EAN-8/JAN-8
(0)

Enable/Disable EAN-13/JAN-13

Parameter # 3

To enable or disable EAN-13/JAN-13, scan the appropriate bar code below.

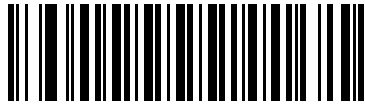

***Enable EAN-13/JAN-13
(1)**

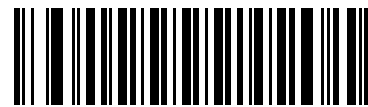

**Disable EAN-13/JAN-13
(0)**

Enable/Disable Bookland EAN

Parameter # 83

To enable or disable Bookland EAN, scan the appropriate bar code below.

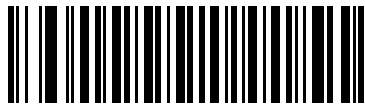

**Enable Bookland EAN
(1)**



***Disable Bookland EAN
(0)**



NOTE If you enable Bookland EAN, select a [Bookland ISBN Format on page 8-20](#). Also select either Decode UPC/EAN Supplementals, Autodiscriminate UPC/EAN Supplementals, or Enable 978/979 Supplemental Mode in [Decode UPC/EAN/JAN Supplementals on page 8-10](#).

Decode UPC/EAN/JAN Supplementals

Parameter # 16

Supplementals are bar codes appended according to specific format conventions (e.g., UPC A+2, UPC E+2, EAN 13+2). The following options are available:

- If you select **Ignore UPC/EAN with Supplementals**, and the scanner is presented with a UPC/EAN plus supplemental symbol, the scanner decodes UPC/EAN and ignores the supplemental characters.
- If you select **Decode UPC/EAN with Supplementals**, the scanner only decodes UPC/EAN symbols with supplemental characters, and ignores symbols without supplementals.
- If you select **Autodiscriminate UPC/EAN Supplementals**, the scanner decodes UPC/EAN symbols with supplemental characters immediately. If the symbol does not have a supplemental, the scanner must decode the bar code the number of times set via [UPC/EAN/JAN Supplemental Redundancy on page 8-13](#) before transmitting its data to confirm that there is no supplemental.
- If you select one of the following **Supplemental Mode** options, the scanner immediately transmits EAN-13 bar codes starting with that prefix that have supplemental characters. If the symbol does not have a supplemental, the scanner must decode the bar code the number of times set via [UPC/EAN/JAN Supplemental Redundancy on page 8-13](#) before transmitting its data to confirm that there is no supplemental. The scanner transmits UPC/EAN bar codes that do not have that prefix immediately.
 - **Enable 378/379 Supplemental Mode**
 - **Enable 978/979 Supplemental Mode**

✓ **NOTE** If you select 978/979 Supplemental Mode and are scanning Bookland EAN bar codes, see [Enable/Disable Bookland EAN on page 8-9](#) to enable Bookland EAN, and select a format using [Bookland ISBN Format on page 8-20](#).

- **Enable 977 Supplemental Mode**
- **Enable 414/419/434/439 Supplemental Mode**
- **Enable 491 Supplemental Mode**
- **Enable Smart Supplemental Mode** - applies to EAN-13 bar codes starting with any prefix listed previously.
- **Supplemental User-Programmable Type 1** - applies to EAN-13 bar codes starting with a 3-digit user-defined prefix. Set this 3-digit prefix using [User-Programmable Supplementals on page 8-13](#).
- **Supplemental User-Programmable Type 1 and 2** - applies to EAN-13 bar codes starting with either of two 3-digit user-defined prefixes. Set the 3-digit prefixes using [User-Programmable Supplementals on page 8-13](#).
- **Smart Supplemental Plus User-Programmable 1** - applies to EAN-13 bar codes starting with any prefix listed previously or the user-defined prefix set using [User-Programmable Supplementals on page 8-13](#).
- **Smart Supplemental Plus User-Programmable 1 and 2** - applies to EAN-13 bar codes starting with any prefix listed previously or one of the two user-defined prefixes set using [User-Programmable Supplementals on page 8-13](#).

✓ **NOTE** To minimize the risk of invalid data transmission, select either to decode or ignore supplemental characters.

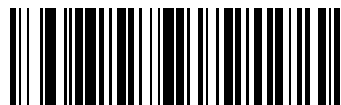
Decode UPC/EAN/JAN Supplementals (continued)

**Decode UPC/EAN/JAN Only With Supplementals
(1)**



***Ignore Supplementals
(0)**



**Autodiscriminate UPC/EAN/JAN Supplementals
(2)**

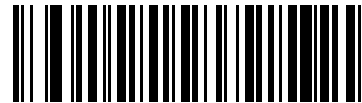

**Enable 378/379 Supplemental Mode
(4)**



**Enable 978/979 Supplemental Mode
(5)**



**Enable 977 Supplemental Mode
(6)**

Decode UPC/EAN/JAN Supplementals (continued)



Enable 414/419/434/439 Supplemental Mode
(6)



Enable 491 Supplemental Mode
(8)



Enable Smart Supplemental Mode
(3)



Supplemental User-Programmable Type 1
(9)



Supplemental User-Programmable Type 1 and 2
(10)



Smart Supplemental Plus User-Programmable 1
(11)



Smart Supplemental Plus User-Programmable 1 and 2
(12)

User-Programmable Supplementals

Supplemental 1: Parameter # 579

Supplemental 2: Parameter # 580

If you selected a Supplemental User-Programmable option from *Decode UPC/EAN/JAN Supplementals on page 8-10*, select **User-Programmable Supplemental 1** to set the 3-digit prefix. Then select the 3 digits using the numeric bar codes beginning on *page E-1*. Select **User-Programmable Supplemental 2** to set a second 3-digit prefix. Then select the 3 digits using the numeric bar codes beginning on *page E-1*. The default is FFF.



User-Programmable Supplemental 1



User-Programmable Supplemental 2

UPC/EAN/JAN Supplemental Redundancy

Parameter # 80

If you selected **Autodiscriminate UPC/EAN/JAN Supplementals**, this option adjusts the number of times to decode a symbol without supplementals before transmission. The range is from two to thirty times. Five or above is recommended when decoding a mix of UPC/EAN/JAN symbols with and without supplementals. The default is 7.

Scan the bar code below to set a decode redundancy value. Next, scan two numeric bar codes in *Appendix E, NUMERIC BAR CODES*. Enter a leading zero for single digit numbers. To correct an error or change a selection, scan *Cancel on page E-3*.

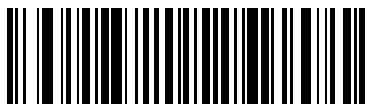

UPC/EAN/JAN Supplemental Redundancy

UPC/EAN/JAN Supplemental AIM ID Format

Parameter # 672

Select an output format when reporting UPC/EAN/JAN bar codes with Supplementals with *Transmit Code ID Character on page 7-20* set to **AIM Code ID Character**:

- **Separate** - transmit UPC/EAN with supplementals with separate AIM IDs but one transmission, i.e.:
]E<0 or 4><data>]E<1 or 2>[supplemental data]
- **Combined** – transmit UPC/EAN with supplementals with one AIM ID and one transmission, i.e.:
]E3<data+supplemental data>
- **Separate Transmissions** - transmit UPC/EAN with supplementals with separate AIM IDs and separate transmissions, i.e.:
]E<0 or 4><data>
]E<1 or 2>[supplemental data]



**Separate
(0)**



***Combined
(1)**



**Separate Transmissions
(2)**

Transmit UPC-A Check Digit

Parameter # 40

The check digit is the last character of the symbol used to verify the integrity of the data. Scan the appropriate bar code below to transmit the bar code data with or without the UPC-A check digit. It is always verified to guarantee the integrity of the data.

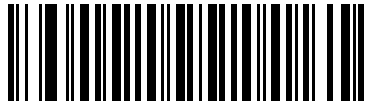

***Transmit UPC-A Check Digit
(1)**

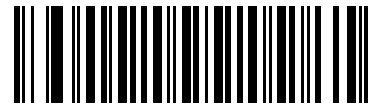

**Do Not Transmit UPC-A Check Digit
(0)**

Transmit UPC-E Check Digit

Parameter # 41

The check digit is the last character of the symbol used to verify the integrity of the data. Scan the appropriate bar code below to transmit the bar code data with or without the UPC-E check digit. It is always verified to guarantee the integrity of the data.

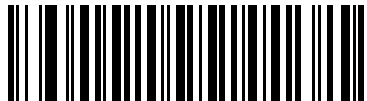

***Transmit UPC-E Check Digit
(1)**



**Do Not Transmit UPC-E Check Digit
(0)**

Transmit UPC-E1 Check Digit

Parameter # 42

The check digit is the last character of the symbol used to verify the integrity of the data. Scan the appropriate bar code below to transmit the bar code data with or without the UPC-E1 check digit. It is always verified to guarantee the integrity of the data.



***Transmit UPC-E1 Check Digit
(1)**

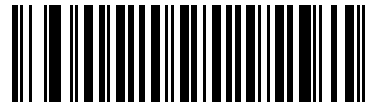

**Do Not Transmit UPC-E1 Check Digit
(0)**

UPC-A Preamble

Parameter # 34

Preamble characters are part of the UPC symbol, and include Country Code and System Character. There are three options for transmitting a UPC-A preamble to the host device: transmit System Character only, transmit System Character and Country Code (“0” for USA), and transmit no preamble. Select the appropriate option to match the host system.

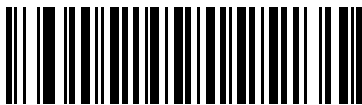

**No Preamble (<DATA>
(0)**

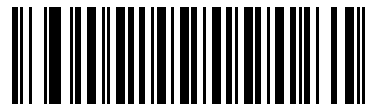

***System Character (<SYSTEM CHARACTER>
<DATA>
(1)**

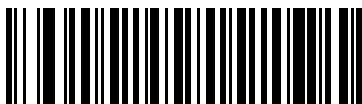

**System Character & Country Code
(< COUNTRY CODE> <SYSTEM CHARACTER>
<DATA>
(2)**

UPC-E Preamble

Parameter # 35

Preamble characters are part of the UPC symbol, and include Country Code and System Character. There are three options for transmitting a UPC-E preamble to the host device: transmit System Character only, transmit System Character and Country Code ("0" for USA), and transmit no preamble. Select the appropriate option to match the host system.

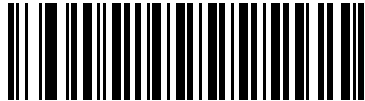

No Preamble (<DATA>)
(0)

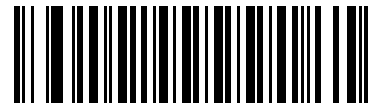

*System Character (<SYSTEM CHARACTER>
<DATA>)
(1)



System Character & Country Code
(< COUNTRY CODE> <SYSTEM CHARACTER>
<DATA>)
(2)

UPC-E1 Preamble

Parameter # 36

Preamble characters are part of the UPC symbol, and include Country Code and System Character. There are three options for transmitting a UPC-E1 preamble to the host device: transmit System Character only, transmit System Character and Country Code ("0" for USA), and transmit no preamble. Select the appropriate option to match the host system.

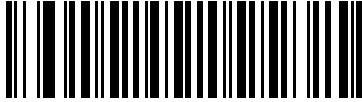

No Preamble (<DATA>)
(0)



***System Character (<SYSTEM CHARACTER> <DATA>)**
(1)

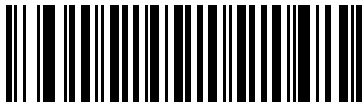

System Character & Country Code
(< COUNTRY CODE> <SYSTEM CHARACTER> <DATA>)
(2)

Convert UPC-E to UPC-A

Parameter # 37

Enable this to convert UPC-E (zero suppressed) decoded data to UPC-A format before transmission. After conversion, the data follows UPC-A format and is affected by UPC-A programming selections (e.g., Preamble, Check Digit).

Disable this to transmit UPC-E decoded data as UPC-E data, without conversion.

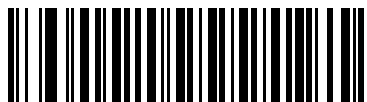

Convert UPC-E to UPC-A (Enable)
(1)



*Do Not Convert UPC-E to UPC-A (Disable)
(0)

Convert UPC-E1 to UPC-A

Parameter # 38

Enable this to convert UPC-E1 decoded data to UPC-A format before transmission. After conversion, the data follows UPC-A format and is affected by UPC-A programming selections (e.g., Preamble, Check Digit).

Disable this to transmit UPC-E1 decoded data as UPC-E1 data, without conversion.

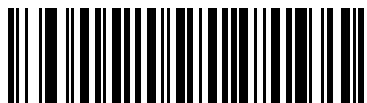

Convert UPC-E1 to UPC-A (Enable)
(1)



*Do Not Convert UPC-E1 to UPC-A (Disable)
(0)

EAN-8/JAN-8 Extend

Parameter # 39

Enable this parameter to add five leading zeros to decoded EAN-8 symbols to make them compatible in format to EAN-13 symbols.

Disable this to transmit EAN-8 symbols as is.

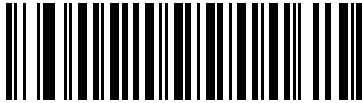

Enable EAN/JAN Zero Extend
(1)

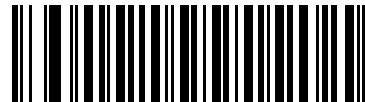

*Disable EAN/JAN Zero Extend
(0)

Bookland ISBN Format

Parameter # 576

If you enabled Bookland EAN using [Enable/Disable Bookland EAN on page 8-9](#), select one of the following formats for Bookland data:

- **Bookland ISBN-10** - The scanner reports Bookland data starting with 978 in traditional 10-digit format with the special Bookland check digit for backward-compatibility. Data starting with 979 is not considered Bookland in this mode.
- **Bookland ISBN-13** - The scanner reports Bookland data (starting with either 978 or 979) as EAN-13 in 13-digit format to meet the 2007 ISBN-13 protocol.



*Bookland ISBN-10
(0)



Bookland ISBN-13
(1)



NOTE For Bookland EAN to function properly, first enable Bookland EAN using [Enable/Disable Bookland EAN on page 8-9](#), then select either Decode UPC/EAN Supplementals, Autodiscriminate UPC/EAN Supplementals, or Enable 978/979 Supplemental Mode in [Decode UPC/EAN/JAN Supplementals on page 8-10](#).

UCC Coupon Extended Code

Parameter # 85

Enable this parameter to decode UPC-A bar codes starting with digit '5', EAN-13 bar codes starting with digit '99', and UPC-A/GS1-128 Coupon Codes. UPCA, EAN-13, and GS1-128 must be enabled to scan all types of Coupon Codes.

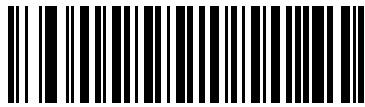

Enable UCC Coupon Extended Code
(1)



*Disable UCC Coupon Extended Code
(0)



NOTE See [UPC/EAN/JAN Supplemental Redundancy on page 8-13](#) to control autodiscrimination of the GS1-128 (right half) of a coupon code.

Coupon Report

Parameter # 730

Select an option to determine which type of coupon format to support.

- Select **Old Coupon Format** to support UPC-A/GS1-128 and EAN-13/GS1-128.
- Select **New Coupon Format** as an interim format to support UPC-A/GS1-DataBar and EAN-13/GS1-DataBar.
- If you select **Autodiscriminate Format**, the scanner supports both **Old Coupon Format** and **New Coupon Format**.



Old Coupon Format
(0)



New Coupon Format
(1)



*Autodiscriminate Coupon Format
(2)

ISSN EAN

Parameter # 617

To enable or disable ISSN EAN, scan the appropriate bar code below.



**Enable ISSN EAN
(1)**



***Disable ISSN EAN
(0)**

Code 128

Enable/Disable Code 128

Parameter # 8

To enable or disable Code 128, scan the appropriate bar code below.

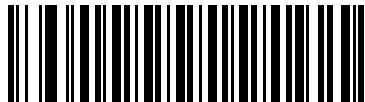

*Enable Code 128
(1)



Disable Code 128
(0)

Set Length(s) for Code 128

Parameter # L1 = 209, L2 = 210

✓ **NOTE** This parameter applies only to scanners branded with a silver logo .

The length of a code refers to the number of characters (i.e., human readable characters), including check digit(s) the code contains. Set length(s) for Code 128 to any length, one or two discrete lengths, or lengths within a specific range. The default option is **Length Within Range**, 1 to 80. The allowable range is 1 to 80.

✓ **NOTE** When setting lengths for different bar code types, enter a leading zero for single digit numbers.

- **One Discrete Length** - Select this option to decode only Code 128 symbols containing a selected length. Select the length using the numeric bar codes in [Appendix E, NUMERIC BAR CODES](#). For example, to decode only Code 128 symbols with 14 characters, scan **Code 128 - One Discrete Length**, then scan **1** followed by **4**. To correct an error or change the selection, scan [Cancel on page E-3](#).
- **Two Discrete Lengths** - Select this option to decode only Code 128 symbols containing either of two selected lengths. Select lengths using the numeric bar codes in [Appendix E, NUMERIC BAR CODES](#). For example, to decode only Code 128 symbols containing either 2 or 14 characters, select **Code 128 - Two Discrete Lengths**, then scan **0, 2, 1**, and then **4**. To correct an error or change the selection, scan [Cancel on page E-3](#).
- **Length Within Range** - Select this option to decode a Code 128 symbol with a specific length range. Select lengths using numeric bar codes in [Appendix E, NUMERIC BAR CODES](#). For example, to decode Code 128 symbols containing between 4 and 12 characters, first scan **Code 128 - Length Within Range**. Then scan **0, 4, 1**, and **2** (enter a leading zero for single digit numbers). To correct an error or change the selection, scan [Cancel on page E-3](#). This is the default option.
- **Any Length** - Select this option to decode Code 128 symbols containing any number of characters within the scanner's capability.

Set Length(s) for Code 128 (continued)

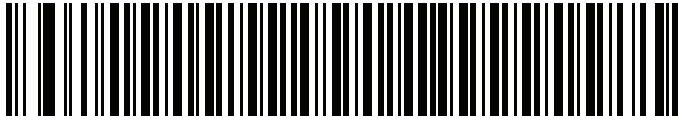

Code 128 - One Discrete Length

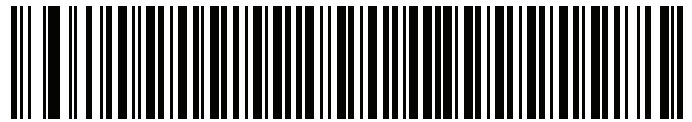

Code 128 - Two Discrete Lengths

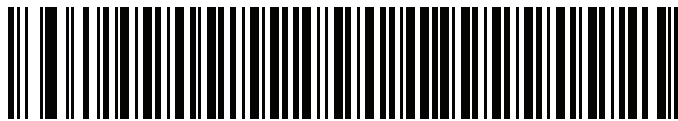

*Code 128 - Length Within Range
(1 to 80)

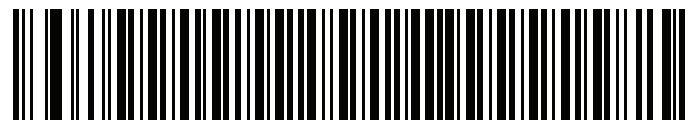

Code 128 - Any Length

Enable/Disable GS1-128 (formerly UCC/EAN-128)

Parameter # 14

To enable or disable GS1-128, scan the appropriate bar code below.

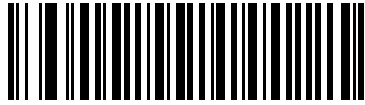

***Enable GS1-128
(1)**

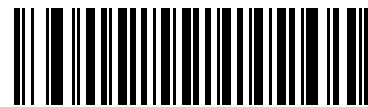

**Disable GS1-128
(0)**

Enable/Disable ISBT 128

Parameter # 84

ISBT 128 is a variant of Code 128 used in the blood bank industry. Scan a bar code below to enable or disable ISBT 128. If necessary, the host must perform concatenation of the ISBT data.



***Enable ISBT 128
(1)**



**Disable ISBT 128
(0)**

ISBT Concatenation

Parameter # 577

✓ **NOTE** This parameter applies only to scanners branded with a silver logo .

Select an option for concatenating pairs of ISBT code types:

- If you select **Disable ISBT Concatenation**, the scanner does not concatenate pairs of ISBT codes it encounters.
- If you select **Enable ISBT Concatenation**, there must be two ISBT codes in order for the scanner to decode and perform concatenation. The scanner does not decode single ISBT symbols.
- If you select **Auto-discriminate ISBT Concatenation**, the scanner decodes and concatenates pairs of ISBT codes immediately. If only a single ISBT symbol is present, the scanner must decode the symbol the number of times set via [ISBT Concatenation Redundancy on page 8-27](#) before transmitting its data to confirm that there is no additional ISBT symbol.



**Disable ISBT Concatenation
(0)**

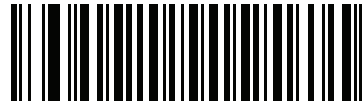

**Enable ISBT Concatenation
(1)**



***Auto-discriminate ISBT Concatenation
(2)**

Check ISBT Table

Parameter # 578

The ISBT specification includes a table that lists several types of ISBT bar codes that are commonly used in pairs. If you set **ISBT Concatenation** to **Enable**, enable **Check ISBT Table** to concatenate only those pairs found in this table. Other types of ISBT codes are not concatenated.



*Enable Check ISBT Table
(1)



Disable Check ISBT Table
(0)

ISBT Concatenation Redundancy

Parameter # 223

If you set **ISBT Concatenation** to **Autodiscriminate**, use this parameter to set the number of times the scanner must decode an ISBT symbol before determining that there is no additional symbol.

Scan the bar code below, then scan two numeric bar codes in [Appendix E, NUMERIC BAR CODES](#) to set a value between 2 and 20. Enter a leading zero for single digit numbers. To correct an error or change a selection, scan [Cancel on page E-3](#). The default is 10.



ISBT Concatenation Redundancy

Code 128 Security Level

Parameter # 751

Code 128 bar codes are vulnerable to misdecodes by the nature of the symbol, especially when **Any Length** is set for Code 128 bar codes. The scanner offers four levels of decode security for Code 128 bar codes. There is an inverse relationship between security and scanner aggressiveness. Increasing the level of security may result in reduced aggressiveness in scanning, so select only the level of security necessary.

- **Code 128 Security Level 0:** This setting allows the scanner to operate in its most aggressive state, while providing sufficient security in decoding the most in-spec bar codes.
- **Code 128 Security Level 1:** A bar code must be successfully read twice, and satisfy certain safety requirements before being decoded. This default setting eliminates most misdecodes.
- **Code 128 Security Level 2:** Select this option with higher safety requirements to the bar codes if **Security Level 1** fails to eliminate misdecodes.
- **Code 128 Security Level 3:** If you selected **Security Level 2**, and misdecodes still occur, select this security level. The highest safety requirements are applied. A bar code must be successfully read three times before being decoded.

✓ **NOTE** Selecting this option is an extreme measure against mis-decoding severely out-of-spec bar codes. Selecting this level of security significantly impairs the decoding ability of the scanner. If this level of security is required, it is recommended that you try to improve the quality of the bar codes.

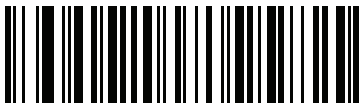

Code 128 Security Level 0
(0)



*Code 128 Security Level 1
(1)



Code 128 Security Level 2
(2)



Code 128 Security Level 3
(3)

Code 39

Enable/Disable Code 39

Parameter # 0

To enable or disable Code 39, scan the appropriate bar code below.

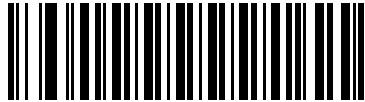

***Enable Code 39**
(1)

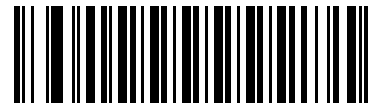

Disable Code 39
(0)

Enable/Disable Trioptic Code 39

Parameter # 13

Trioptic Code 39 is a variant of Code 39 used in the marking of computer tape cartridges. Trioptic Code 39 symbols always contain six characters. To enable or disable Trioptic Code 39, scan the appropriate bar code below.

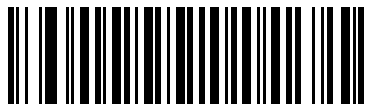

Enable Trioptic Code 39
(1)



***Disable Trioptic Code 39**
(0)



NOTE You cannot enable Trioptic Code 39 and Code 39 Full ASCII simultaneously.

Convert Code 39 to Code 32

Parameter # 86

Code 32 is a variant of Code 39 used by the Italian pharmaceutical industry. Scan the appropriate bar code below to enable or disable converting Code 39 to Code 32.

✓ **NOTE** Code 39 must be enabled for this parameter to function.



Enable Convert Code 39 to Code 32
(1)

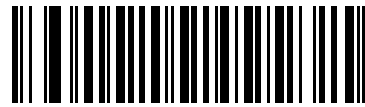

*Disable Convert Code 39 to Code 32
(0)

Code 32 Prefix

Parameter # 231

Scan the appropriate bar code below to enable or disable adding the prefix character "A" to all Code 32 bar codes.

✓ **NOTE** Convert Code 39 to Code 32 must be enabled for this parameter to function.

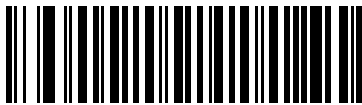

Enable Code 32 Prefix
(1)



*Disable Code 32 Prefix
(0)

Set Length(s) for Code 39

Parameter # L1 = 18, L2 = 19

The length of a code refers to the number of characters (i.e., human readable characters), including check digit(s) the code contains. Set lengths for Code 39 to any length, one or two discrete lengths, or lengths within a specific range. If Code 39 Full ASCII is enabled, **Length Within a Range** or **Any Length** are the preferred options. The default option is **Length Within Range**, 2 to 55. The allowable range is 1 to 80.

✓ **NOTE** When setting lengths for different bar code types, enter a leading zero for single digit numbers.

- **One Discrete Length** - Select this option to decode only Code 39 symbols containing a selected length. Select the length using the numeric bar codes in [Appendix E, NUMERIC BAR CODES](#). For example, to decode only Code 39 symbols with 14 characters, scan **Code 39 - One Discrete Length**, then scan **1** followed by **4**. To correct an error or change the selection, scan [Cancel on page E-3](#).
- **Two Discrete Lengths** - Select this option to decode only Code 39 symbols containing either of two selected lengths. Select lengths using the numeric bar codes in [Appendix E, NUMERIC BAR CODES](#). For example, to decode only Code 39 symbols containing either 2 or 14 characters, select **Code 39 - Two Discrete Lengths**, then scan **0, 2, 1**, and then **4**. To correct an error or change the selection, scan [Cancel on page E-3](#).
- **Length Within Range** - Select this option to decode a Code 39 symbol with a specific length range. Select lengths using numeric bar codes in [Appendix E, NUMERIC BAR CODES](#). For example, to decode Code 39 symbols containing between 4 and 12 characters, first scan **Code 39 - Length Within Range**. Then scan **0, 4, 1**, and **2** (enter a leading zero for single digit numbers). To correct an error or change the selection, scan [Cancel on page E-3](#). This is the default option.
- **Any Length** - Select this option to decode Code 39 symbols containing any number of characters within the scanner's capability.



Code 39 - One Discrete Length



Code 39 - Two Discrete Lengths



*Code 39 - Length Within Range
(1 to 80)



Code 39 - Any Length

Code 39 Check Digit Verification

Parameter # 48

Enable this feature to check the integrity of all Code 39 symbols to verify that the data complies with specified check digit algorithm. Only Code 39 symbols which include a modulo 43 check digit are decoded. Enable this feature if the Code 39 symbols contain a Modulo 43 check digit.

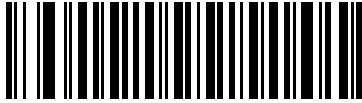

Enable Code 39 Check Digit
(1)

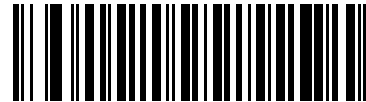

*Disable Code 39 Check Digit
(0)

Transmit Code 39 Check Digit

Parameter # 43

Scan a bar code below to transmit Code 39 data with or without the check digit.

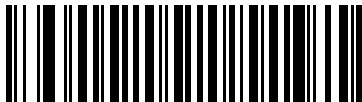

Transmit Code 39 Check Digit (Enable)
(1)



*Do Not Transmit Code 39 Check Digit (Disable)
(0)



NOTE Code 39 Check Digit Verification must be enabled for this parameter to function.

Code 39 Full ASCII Conversion

Parameter # 17

Code 39 Full ASCII is a variant of Code 39 which pairs characters to encode the full ASCII character set. To enable or disable Code 39 Full ASCII, scan the appropriate bar code below.



Enable Code 39 Full ASCII
(1)

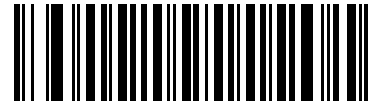

*Disable Code 39 Full ASCII
(0)



NOTE You cannot enable Trioptic Code 39 and Code 39 Full ASCII simultaneously.

Code 39 Full ASCII to Full ASCII Correlation is host-dependent, and is therefore described in the ASCII Character Set Table for the appropriate interface. See the [ASCII Character Set for RS-232 on page 4-20](#) or the [ASCII Character Set for USB on page 3-17](#).

Code 39 Buffering - Scan & Store

Parameter # 113

This feature allows the scanner to accumulate data from multiple Code 39 symbols.

Selecting the Scan and Store option (Buffer Code 39) temporarily buffers all Code 39 symbols having a leading space as a first character for later transmission. The leading space is not buffered.

Decoding a Code 39 symbol with no leading space transmits in sequence all buffered data in a first-in first-out format, plus the “triggering” symbol. See the following pages for further details.

Select **Do Not Buffer Code 39** to transmit all decoded Code 39 symbols immediately without storing them in the buffer.

This feature affects Code 39 only. If selecting **Buffer Code 39**, we recommend configuring the scanner to decode Code 39 symbology only.

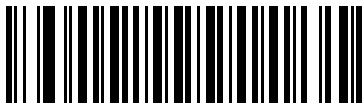

Buffer Code 39 (Enable)
(1)

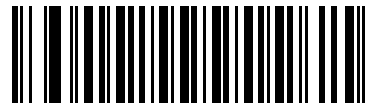

***Do Not Buffer Code 39 (Disable)**
(0)

While there is data in the transmission buffer, you cannot select **Do Not Buffer Code 39**. The buffer holds 200 bytes of information.

To disable Code 39 buffering when there is data in the transmission buffer, first force the buffer transmission (see [Transmit Buffer on page 8-35](#)) or clear the buffer.

Buffer Data

To buffer data, enable Code 39 buffering and scan a Code 39 symbol with a space immediately following the start pattern.

- Unless the data overflows the transmission buffer, the scanner issues a low/high beep to indicate successful decode and buffering. (For overflow conditions, see [Overfilling Transmission Buffer on page 8-35](#).)
- The scanner adds the decoded data excluding the leading space to the transmission buffer.
- No transmission occurs.

Clear Transmission Buffer

To clear the transmission buffer, scan the **Clear Buffer** bar code below, which contains only a start character, a dash (minus), and a stop character.

- The scanner issues a short high/low/high beep.
- The scanner erases the transmission buffer.
- No transmission occurs.

**Clear Buffer**

- ✓ **NOTE** The Clear Buffer contains only the dash (minus) character. In order to scan this command, set Code 39 lengths to include length 1.

Transmit Buffer

There are two methods to transmit the Code 39 buffer.

1. Scan the **Transmit Buffer** bar code below, which includes only a start character, a plus (+), and a stop character.
2. The scanner transmits and clears the buffer.
 - The scanner issues a low/high beep.

**Transmit Buffer**

3. Scan a Code 39 bar code with a leading character other than a space.
 - The scanner appends new decode data to buffered data.
 - The scanner transmits and clears the buffer.
 - The scanner signals that it transmitted the buffer with a low/high beep.
 - The scanner transmits and clears the buffer.

- ✓ **NOTE** The Transmit Buffer contains only a plus (+) character. In order to scan this command, set Code 39 lengths to include length 1.

Overfilling Transmission Buffer

The Code 39 buffer holds 200 characters. If the symbol just read overflows the transmission buffer:

- The scanner indicates that it rejected the symbol by issuing three long, high beeps.
- No transmission occurs. The data in the buffer is not affected.

Attempt to Transmit an Empty Buffer

If you scan the **Transmit Buffer** symbol and the Code 39 buffer is empty:

- A short low/high/low beep signals that the buffer is empty.
- No transmission occurs.
- The buffer remains empty.

Code 39 Security Level

Parameter # 750

✓ **NOTE** This parameter applies only to scanners branded with a silver logo .

The scanner offers four levels of decode security for Code 39. Select increasing levels of security for decreasing levels of bar code quality. There is an inverse relationship between security and scanner aggressiveness, so choose only that level of security necessary for any given application.

- **Code 39 Security Level 0:** This setting allows the scanner to operate in its most aggressive state, while providing sufficient security in decoding most “in-spec” bar codes.
- **Code 39 Security Level 1:** This default setting eliminates most misdecodes.
- **Code 39 Security Level 2:** Select this option if Security level 1 fails to eliminate misdecodes.
- **Code 39 Security Level 3:** If you selected Security Level 2 and misdecodes still occur, select this security level. Be advised, selecting this option is an extreme measure against mis-decoding severely out of spec bar codes. Selecting this level of security significantly impairs the decoding ability of the scanner. If you need this level of security, try to improve the quality of the bar codes.



**Code 39 Security Level 0
(0)**



***Code 39 Security Level 1
(1)**



**Code 39 Security Level 2
(2)**



**Code 39 Security Level 3
(3)**

Code 93

Enable/Disable Code 93

Parameter # 9

To enable or disable Code 93, scan the appropriate bar code below.

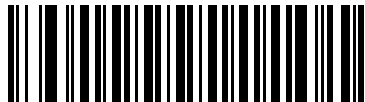

Enable Code 93
(1)

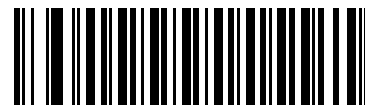

*Disable Code 93
(0)

Set Length(s) for Code 93

Parameter # L1 = 26, L2 = 27

The length of a code refers to the number of characters (i.e., human readable characters), including check digit(s) the code contains. Set lengths for Code 93 to any length, one or two discrete lengths, or lengths within a specific range. The default option is **Length Within Range**, 4 to 55. The allowable range is 1 to 80.

- **One Discrete Length** - Select this option to decode only Code 93 symbols containing a selected length. Select the length using the numeric bar codes in [Appendix E, NUMERIC BAR CODES](#). For example, to decode only Code 93 symbols with 14 characters, scan **Code 93 - One Discrete Length**, then scan **1** followed by **4**. To correct an error or to change the selection, scan [Cancel on page E-3](#).
- **Two Discrete Lengths** - Select this option to decode only Code 93 symbols containing either of two selected lengths. Select lengths using the numeric bar codes in [Appendix E, NUMERIC BAR CODES](#). For example, to decode only Code 93 symbols containing either 2 or 14 characters, select **Code 93 - Two Discrete Lengths**, then scan **0, 2, 1**, and then **4**. To correct an error or to change the selection, scan [Cancel on page E-3](#).
- **Length Within Range** - Select this option to decode a Code 93 symbol with a specific length range. Select lengths using the numeric bar codes in [Appendix E, NUMERIC BAR CODES](#). For example, to decode Code 93 symbols containing between 4 and 12 characters, first scan **Code 93 - Length Within Range**. Then scan **0, 4, 1**, and **2** (enter a leading zero for single digit numbers). To correct an error or change the selection, scan [Cancel on page E-3](#). This is the default option.
- **Any Length** - Scan this option to decode Code 93 symbols containing any number of characters within the scanner's capability.

Set Length(s) for Code 93 (continued)



Code 93 - One Discrete Length



Code 93 - Two Discrete Lengths



*** Code 93 - Length Within Range
(1 to 80)**



Code 93 - Any Length

Code 11

Code 11

Parameter # 10

To enable or disable Code 11, scan the appropriate bar code below.

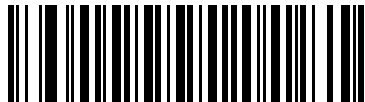

Enable Code 11
(1)

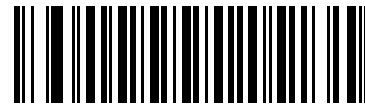

*Disable Code 11
(0)

Set Length(s) for Code 11

Parameter # L1 = 28, L2 = 29

The length of a code refers to the number of characters (i.e., human readable characters), including check digit(s) the code contains. Set lengths for Code 11 to any length, one or two discrete lengths, or lengths within a specific range. The default option is **Length Within Range**, 4 to 55. The allowable range is 4 to 80.

- **One Discrete Length** - Select this option to decode only Code 11 symbols containing a selected length. Select the length using the numeric bar codes in [Appendix E, NUMERIC BAR CODES](#). For example, to decode only Code 11 symbols with 14 characters, scan **Code 11 - One Discrete Length**, then scan **1** followed by **4**. To correct an error or to change the selection, scan [Cancel on page E-3](#).
- **Two Discrete Lengths** - Select this option to decode only Code 11 symbols containing either of two selected lengths. Select lengths using the numeric bar codes in [Appendix E, NUMERIC BAR CODES](#). For example, to decode only Code 11 symbols containing either 2 or 14 characters, select **Code 11 - Two Discrete Lengths**, then scan **0, 2, 1**, and then **4**. To correct an error or to change the selection, scan [Cancel on page E-3](#).
- **Length Within Range** - Select this option to decode a Code 11 symbol with a specific length range. Select lengths using numeric bar codes in [Appendix E, NUMERIC BAR CODES](#). For example, to decode Code 11 symbols containing between 4 and 12 characters, first scan **Code 11 - Length Within Range**. Then scan **0, 4, 1**, and **2** (enter a leading zero for single digit numbers). To correct an error or change the selection, scan [Cancel on page E-3](#). This is the default option.
- **Any Length** - Scan this option to decode Code 11 symbols containing any number of characters within the scanner's capability.

Set Length(s) for Code 11 (continued)



Code 11 - One Discrete Length



Code 11 - Two Discrete Lengths



*** Code 11 - Length Within Range
(4 to 80)**



Code 11 - Any Length

Code 11 Check Digit Verification

Parameter # 52

This feature allows the scanner to check the integrity of all Code 11 symbols to verify that the data complies with the specified check digit algorithm. This selects the check digit mechanism for the decoded Code 11 bar code. The options are to check for one check digit, check for two check digits, or disable the feature.

To enable this feature, scan the bar code below corresponding to the number of check digits encoded in the Code 11 symbols.

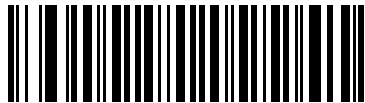

***Disable**
(0)



One Check Digit
(1)

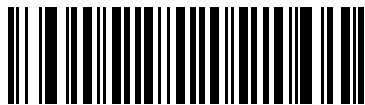

Two Check Digits
(2)

Transmit Code 11 Check Digits

Parameter # 47

This feature selects whether or not to transmit the Code 11 check digit(s).

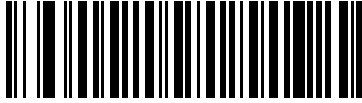

Transmit Code 11 Check Digit(s) (Enable)
(1)

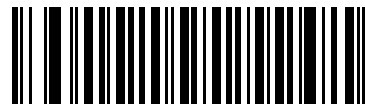

*Do Not Transmit Code 11 Check Digit(s) (Disable)
(0)



NOTE Code 11 Check Digit Verification must be enabled for this parameter to function.

Interleaved 2 of 5 (ITF)

Enable/Disable Interleaved 2 of 5

Parameter # 6

To enable or disable Interleaved 2 of 5, scan the appropriate bar code below, and select an Interleaved 2 of 5 length from the following pages.

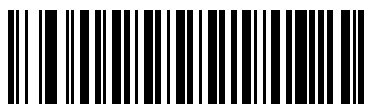

*Enable Interleaved 2 of 5
(1)

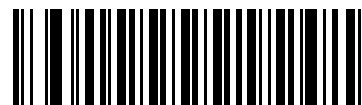

Disable Interleaved 2 of 5
(0)

Set Length(s) for Interleaved 2 of 5

Parameter # L1 = 22, L2 = 23

The length of a code refers to the number of characters (i.e., human readable characters), including check digit(s) the code contains. Set lengths for I 2 of 5 to any length, one or two discrete lengths, or lengths within a specific range. The default option is **One Discrete Length: 14**. The maximum upper range value is 80.

- **One Discrete Length** - Select this option to decode only I 2 of 5 symbols containing a selected length. Select the length using the numeric bar codes in [Appendix E, NUMERIC BAR CODES](#). For example, to decode only I 2 of 5 symbols with 14 characters, scan **I 2 of 5 - One Discrete Length**, then scan **1** followed by **4**. To correct an error or to change the selection, scan [Cancel on page E-3](#). This is the default option.
- **Two Discrete Lengths** - Select this option to decode only I 2 of 5 symbols containing either of two selected lengths. Select lengths using the numeric bar codes in [Appendix E, NUMERIC BAR CODES](#). For example, to decode only I 2 of 5 symbols containing either 2 or 14 characters, select **I 2 of 5 - Two Discrete Lengths**, then scan **0, 2, 1**, and then **4**. To correct an error or to change the selection, scan [Cancel on page E-3](#).
- **Length Within Range** - Select this option to decode an I 2 of 5 symbol with a specific length range. Select lengths using numeric bar codes in [Appendix E, NUMERIC BAR CODES](#). For example, to decode I 2 of 5 symbols containing between 4 and 12 characters, first scan **I 2 of 5 - Length Within Range**. Then scan **0, 4, 1**, and **2** (enter a leading zero for single digit numbers). To correct an error or change the selection, scan [Cancel on page E-3](#).
- **Any Length** - Scan this option to decode I 2 of 5 symbols containing any number of characters within the scanner's capability.

✓ **NOTE** Due to the construction of the I 2 of 5 symbology, it is possible for a scan line covering only a portion of the code to transmit as a complete scan, yielding less data than is encoded in the bar code. To prevent this, select specific lengths (I 2 of 5 - One Discrete Length, Two Discrete Lengths) for I 2 of 5 applications.

Set Length(s) for Interleaved 2 of 5 (continued)



***I 2 of 5 - One Discrete Length**



I 2 of 5 - Two Discrete Lengths



**I 2 of 5 - Length Within Range
(6 to 80)**



I 2 of 5 - Any Length

I 2 of 5 Check Digit Verification

Parameter # 49

Enable this feature to check the integrity of all I 2 of 5 symbols to verify the data complies with either the specified Uniform Symbology Specification (USS), or the Optical Product Code Council (OPCC) check digit algorithm.



***Disable**
(0)



USS Check Digit
(1)



OPCC Check Digit
(2)

Transmit I 2 of 5 Check Digit

Parameter # 44

Scan the appropriate bar code below to transmit I 2 of 5 data with or without the check digit.

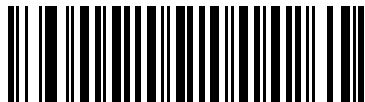

Transmit I 2 of 5 Check Digit (Enable)
(1)



***Do Not Transmit I 2 of 5 Check Digit (Disable)**
(0)

Convert I 2 of 5 to EAN-13

Parameter # 82

Enable this parameter to convert 14-character I 2 of 5 codes to EAN-13, and transmit to the host as EAN-13. To accomplish this, the I 2 of 5 code must be enabled, and the code must have a leading zero and a valid EAN-13 check digit.



Convert I 2 of 5 to EAN-13 (Enable)
(1)

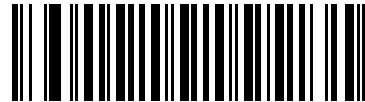

***Do Not Convert I 2 of 5 to EAN-13 (Disable)**
(0)

I 2 of 5 Security Level

Parameter # 1121

✓ **NOTE** This parameter applies only to scanners branded with a silver logo .

Interleaved 2 of 5 bar codes are vulnerable to misdecodes by the nature of the symbol, especially when **Any Length** is set for Interleaved 2 of 5 bar codes. The scanner offers four levels of decode security for Interleaved 2 of 5 bar codes. There is an inverse relationship between security and scanner aggressiveness. Increasing the level of security may result in reduced aggressiveness in scanning, so select only the level of security necessary.

- **I 2 of 5 Security Level 0:** This setting allows the scanner to operate in its most aggressive state, while providing sufficient security in decoding the most in-spec bar codes.
- **I 2 of 5 Security Level 1:** A bar code must be successfully read twice, and satisfy certain safety requirements before being decoded. This default setting eliminates most misdecodes.
- **I 2 of 5 Security Level 2:** Select this option with higher safety requirements to the bar codes if **Security Level 1** fails to eliminate misdecodes.
- **I 2 of 5 Security Level 3:** If you selected **Security Level 2**, and misdecodes still occur, select this security level. The highest safety requirements are applied. A bar code must be successfully read three times before being decoded.

✓ **NOTE** Selecting this option is an extreme measure against mis-decoding severely out-of-spec bar codes. Selecting this level of security significantly impairs the decoding ability of the scanner. If this level of security is required, it is recommended that you try to improve the quality of the bar codes.

I 2 of 5 Security Level (continued)



I 2 of 5 Security Level 0
(0)

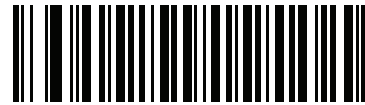

*I 2 of 5 Security Level 1
(1)



I 2 of 5 Security Level 2
(2)



I 2 of 5 Security Level 3
(3)

Discrete 2 of 5 (DTF)

Enable/Disable Discrete 2 of 5

Parameter # 5

To enable or disable Discrete 2 of 5, scan the appropriate bar code below.

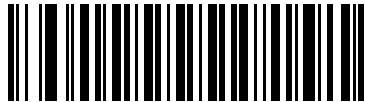

Enable Discrete 2 of 5
(1)

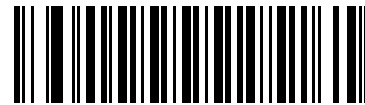

*Disable Discrete 2 of 5
(0)

Set Length(s) for Discrete 2 of 5

Parameter # L1 = 20, L2 = 21

The length of a code refers to the number of characters (i.e., human readable characters), including check digit(s) the code contains. Set lengths for D 2 of 5 to any length, one or two discrete lengths, or lengths within a specific range. The default option is **One Discrete Length: 12**. The allowable range is 1 to 55.

- **One Discrete Length** - Select this option to decode only D 2 of 5 symbols containing a selected length. Select the length using the numeric bar codes in [Appendix E, NUMERIC BAR CODES](#). For example, to decode only D 2 of 5 symbols with 14 characters, scan **D 2 of 5 - One Discrete Length**, then scan **1** followed by **4**. To correct an error or to change the selection, scan [Cancel on page E-3](#). This is the default option.
- **Two Discrete Lengths** - Select this option to decode only D 2 of 5 symbols containing either of two selected lengths. Select lengths using the numeric bar codes in [Appendix E, NUMERIC BAR CODES](#). For example, to decode only D 2 of 5 symbols containing either 2 or 14 characters, select **D 2 of 5 - Two Discrete Lengths**, then scan **0, 2, 1**, and then **4**. To correct an error or to change the selection, scan [Cancel on page E-3](#).
- **Length Within Range** - Select this option to decode a D 2 of 5 symbol with a specific length range. Select lengths using numeric bar codes in [Appendix E, NUMERIC BAR CODES](#). For example, to decode D 2 of 5 symbols containing between 4 and 12 characters, first scan **D 2 of 5 - Length Within Range**. Then scan **0, 4, 1**, and **2** (enter a leading zero for single digit numbers). To correct an error or change the selection, scan [Cancel on page E-3](#).
- **Any Length** - Scan this option to decode D 2 of 5 symbols containing any number of characters within the scanner's capability.

✓ **NOTE** Due to the construction of the D 2 of 5 symbology, it is possible for a scan line covering only a portion of the code to transmit as a complete scan, yielding less data than is encoded in the bar code. To prevent this, select specific lengths (**D 2 of 5 - One Discrete Length, Two Discrete Lengths**) for D 2 of 5 applications.

Set Length(s) for Discrete 2 of 5 (continued)



***D 2 of 5 - One Discrete Length**



D 2 of 5 - Two Discrete Lengths



**D 2 of 5 - Length Within Range
(1 to 55)**



D 2 of 5 - Any Length

Codabar (NW - 7)

Enable/Disable Codabar

Parameter # 7

To enable or disable Codabar, scan the appropriate bar code below.



Enable Codabar
(1)



*Disable Codabar
(0)

Set Length(s) for Codabar

Parameter # L1 = 24, L2 = 25

The length of a code refers to the number of characters (i.e., human readable characters), including check digit(s) the code contains. Set lengths for Codabar to any length, one or two discrete lengths, or lengths within a specific range. The default option is **Length Within Range**, 5 to 55. The allowable range is 4 to 60.

- **One Discrete Length** - Select this option to decode only Codabar symbols containing a selected length. Select the length using the numeric bar codes in [Appendix E, NUMERIC BAR CODES](#). For example, to decode only Codabar symbols with 14 characters, scan **Codabar - One Discrete Length**, then scan **1** followed by **4**. To correct an error or to change the selection, scan [Cancel on page E-3](#).
- **Two Discrete Lengths** - Select this option to decode only Codabar symbols containing either of two selected lengths. Select lengths using the numeric bar codes in [Appendix E, NUMERIC BAR CODES](#). For example, to decode only Codabar symbols containing either 2 or 14 characters, select **Codabar - Two Discrete Lengths**, then scan **0, 2, 1**, and then **4**. To correct an error or to change the selection, scan [Cancel on page E-3](#).
- **Length Within Range** - Select this option to decode a Codabar symbol with a specific length range. Select lengths using numeric bar codes in [Appendix E, NUMERIC BAR CODES](#). For example, to decode Codabar symbols containing between 4 and 12 characters, first scan **Codabar - Length Within Range**. Then scan **0, 4, 1**, and **2** (enter a leading zero for single digit numbers). To correct an error or change the selection, scan [Cancel on page E-3](#). This is the default option.
- **Any Length** - Scan this option to decode Codabar symbols containing any number of characters within the scanner's capability.

Set Length(s) for Codabar (continued)



Codabar - One Discrete Length



Codabar - Two Discrete Lengths



* Codabar - Length Within Range
(4 to 60)



Codabar - Any Length

CLSI Editing

Parameter # 54

Enable this parameter to strip the start and stop characters and insert a space after the first, fifth, and tenth characters of a 14-character Codabar symbol. Enable this feature if the host system requires this data format.

✓ **NOTE** Symbol length does not include start and stop characters.

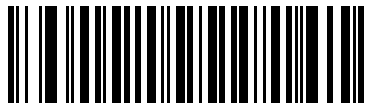

Enable CLSI Editing
(1)

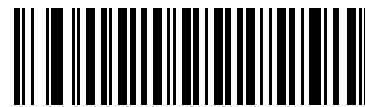

*Disable CLSI Editing
(0)

NOTIS Editing

Parameter # 55

Enable this parameter to strip the start and stop characters from a decoded Codabar symbol. Enable this feature if the host system requires this data format.

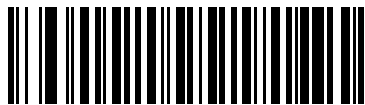

Enable NOTIS Editing
(1)

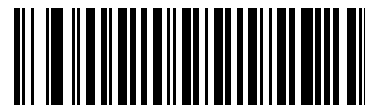

*Disable NOTIS Editing
(0)

Codabar Upper or Lower Case Start/Stop Characters Transmission

Parameter # 855

Select whether to transmit upper case or lower case Codabar start/stop characters.

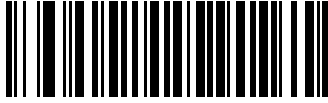

**Lower Case
(1)**

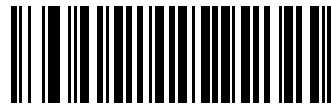

***Upper Case
(0)**

MSI

Enable/Disable MSI

Parameter # 11

To enable or disable MSI, scan the appropriate bar code below.

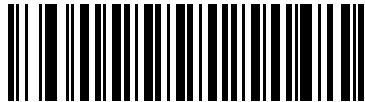

Enable MSI
(1)



***Disable MSI**
(0)

Set Length(s) for MSI

Parameter # L1 = 30, L2 = 31

The length of a code refers to the number of characters (i.e., human readable characters), including check digit(s) the code contains. Set lengths for MSI to any length, one or two discrete lengths, or lengths within a specific range. The default option is **Length Within Range**. The allowable range is 4 to 55.

- **One Discrete Length** - Select this option to decode only MSI symbols containing a selected length. Select the length using the numeric bar codes in [Appendix E, NUMERIC BAR CODES](#). For example, to decode only MSI symbols with 14 characters, scan **MSI - One Discrete Length**, then scan **1** followed by **4**. To correct an error or to change the selection, scan [Cancel on page E-3](#).
- **Two Discrete Lengths** - Select this option to decode only MSI symbols containing either of two selected lengths. Select lengths using the numeric bar codes in [Appendix E, NUMERIC BAR CODES](#). For example, to decode only MSI symbols containing either 2 or 14 characters, select **MSI - Two Discrete Lengths**, then scan **0, 2, 1**, and then **4**. To correct an error or to change the selection, scan [Cancel on page E-3](#).
- **Length Within Range** - Select this option to decode a MSI symbol with a specific length range. Select lengths using numeric bar codes in [Appendix E, NUMERIC BAR CODES](#). For example, to decode MSI symbols containing between 4 and 12 characters, first scan **MSI - Length Within Range**. Then scan **0, 4, 1**, and **2** (enter a leading zero for single digit numbers). To correct an error or change the selection, scan [Cancel on page E-3](#). This is the default option.
- **Any Length** - Scan this option to decode MSI symbols containing any number of characters within the scanner's capability.

Set Length(s) for MSI (continued)

- ✓ **NOTE** Due to the construction of the MSI symbology, it is possible for a scan line covering only a portion of the code to transmit as a complete scan, yielding less data than is encoded in the bar code. To prevent this, select specific lengths (**MSI - One Discrete Length**, **Two Discrete Lengths**) for MSI applications.



MSI - One Discrete Length



MSI - Two Discrete Lengths

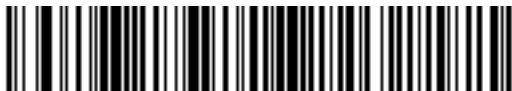

*** MSI - Length Within Range
(4 to 55)**



MSI - Any Length

MSI Check Digits

Parameter # 50

With MSI symbols, one check digit is mandatory and always verified by the reader. The second check digit is optional. If the MSI codes include two check digits, scan the **Two MSI Check Digits** bar code to enable verification of the second check digit.

See [MSI Check Digit Algorithm on page 8-58](#) for the selection of second digit algorithms.

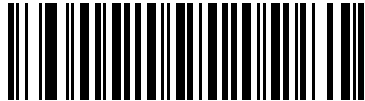

***One MSI Check Digit
(0)**

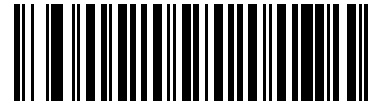

**Two MSI Check Digits
(1)**

Transmit MSI Check Digit(s)

Parameter # 46

Scan a bar code below to transmit MSI data with or without the check digit.

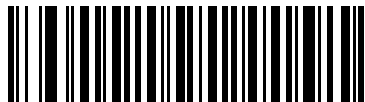

**Transmit MSI Check Digit(s) (Enable)
(1)**



***Do Not Transmit MSI Check Digit(s) (Disable)
(0)**

MSI Check Digit Algorithm

Parameter # 51

Two algorithms are possible for the verification of the second MSI check digit. Select the bar code below corresponding to the algorithm used to encode the check digit.

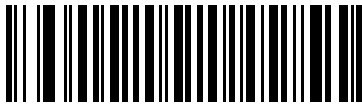

MOD 10/MOD 11
(0)

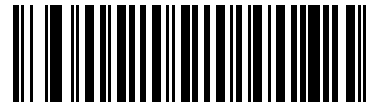

***MOD 10/MOD 10**
(1)

Chinese 2 of 5

Enable/Disable Chinese 2 of 5

Parameter # 408

To enable or disable Chinese 2 of 5, scan the appropriate bar code below.



Enable Chinese 2 of 5
(1)



*Disable Chinese 2 of 5
(0)

Matrix 2 of 5

✓ **NOTE** Matrix 2 of 5 parameters apply only to scanners branded with a silver logo .

Enable/Disable Matrix 2 of 5

Parameter # 618

To enable or disable Matrix 2 of 5, scan the appropriate bar code below.



Enable Matrix 2 of 5
(1)

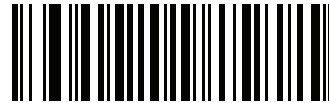

*Disable Matrix 2 of 5
(0)

Set Length(s) for Matrix 2 of 5

Parameter # L1 = 619, L2 = 620

The length of a code refers to the number of characters (i.e., human readable characters), including check digit(s) the code contains. Set lengths for Matrix 2 of 5 to any length, one or two discrete lengths, or lengths within a specific range. The default option is **Length Within Range**. The allowable range is 4 to 80.

- **One Discrete Length** - Select this option to decode only Matrix 2 of 5 symbols containing a selected length. Select the length using the numeric bar codes in [Appendix E, NUMERIC BAR CODES](#). For example, to decode only Matrix 2 of 5 symbols with 14 characters, scan **Matrix 2 of 5 - One Discrete Length**, then scan **1** followed by **4**. To correct an error or to change the selection, scan [Cancel on page E-3](#).
- **Two Discrete Lengths** - Select this option to decode only Matrix 2 of 5 symbols containing either of two selected lengths. Select lengths using the numeric bar codes in [Appendix E, NUMERIC BAR CODES](#). For example, to decode only Matrix 2 of 5 symbols containing either 2 or 14 characters, select **Matrix 2 of 5 - Two Discrete Lengths**, then scan **0, 2, 1**, and then **4**. To correct an error or to change the selection, scan [Cancel on page E-3](#).
- **Length Within Range** - Select this option to decode a Matrix 2 of 5 symbol with a specific length range. Select lengths using the numeric bar codes in [Appendix E, NUMERIC BAR CODES](#). For example, to decode Matrix 2 of 5 symbols containing between 4 and 12 characters, first scan **Matrix 2 of 5 - Length Within Range**. Then scan **0, 4, 1**, and **2** (enter a leading zero for single digit numbers). To correct an error or change the selection, scan [Cancel on page E-3](#). This is the default option.
- **Any Length** - Scan this option to decode Matrix 2 of 5 symbols containing any number of characters within the scanner's capability.

Set Length(s) for Matrix 2 of 5 (continued)**Matrix 2 of 5 - One Discrete Length****Matrix 2 of 5 - Two Discrete Lengths***** Matrix 2 of 5 - Length Within Range
(4 to 80)****Matrix 2 of 5 - Any Length**

Matrix 2 of 5 Check Digit

Parameter # 622

The check digit is the last character of the symbol used to verify the integrity of the data. Scan the appropriate bar code below to transmit the bar code data with or without the Matrix 2 of 5 check digit.

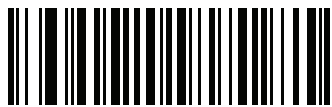

**Enable Matrix 2 of 5 Check Digit
(1)**



***Disable Matrix 2 of 5 Check Digit
(0)**

Transmit Matrix 2 of 5 Check Digit

Parameter # 623

Scan a bar code below to transmit Matrix 2 of 5 data with or without the check digit.



**Transmit Matrix 2 of 5 Check Digit
(1)**

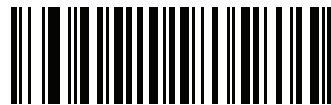

***Do Not Transmit Matrix 2 of 5 Check Digit
(0)**

Korean 3 of 5

Enable/Disable Korean 3 of 5

Parameter # 581

To enable or disable Korean 3 of 5, scan the appropriate bar code below.

✓ **NOTE** The length for Korean 3 of 5 is fixed at 6.



**Enable Korean 3 of 5
(1)**

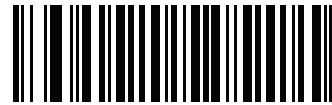

***Disable Korean 3 of 5
(0)**

GS1 DataBar

The variants of GS1 DataBar are DataBar-14, DataBar Expanded, and DataBar Limited. The limited and expanded versions have stacked variants. Scan the appropriate bar codes to enable or disable each variant of GS1 DataBar.

GS1 DataBar-14

Parameter # 338

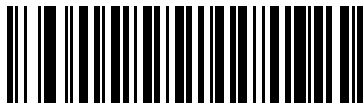

Enable GS1 DataBar-14
(1)



*Disable GS1 DataBar-14
(0)

GS1 DataBar Limited

Parameter # 339

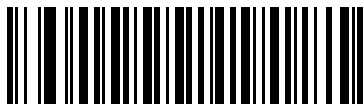

Enable GS1 DataBar Limited
(1)



*Disable GS1 DataBar Limited
(0)

GS1 DataBar Expanded

Parameter # 340

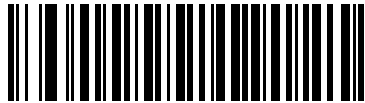

Enable GS1 DataBar Expanded
(1)

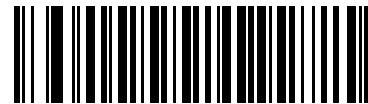

*Disable GS1 DataBar Expanded
(0)

GS1 DataBar Limited Security Level

Parameter # 728

✓ **NOTE** This parameter applies only to scanners branded with a silver logo .

The scanner offers four levels of decode security for GS1 DataBar Limited bar codes. There is an inverse relationship between security and scanner aggressiveness. Increasing the level of security may result in reduced aggressiveness in scanning, so choose only that level of security necessary.

- **GS1 DataBar Limited Security Level 1:** No clear margin required. This complies with the original GS1 standard, yet might result in erroneous decoding of the DataBar Limited bar code when scanning some UPC symbols that start with digits “9” and “7”
- **GS1 DataBar Limited Security Level 2:** Automatic risk detection. This level of security may result in erroneous decoding of DataBar Limited bar codes when scanning some UPC symbols. The scanner defaults to Level 3, otherwise to Level 1.
- **GS1 DataBar Limited Security Level 3:** Security level reflects newly proposed GS1 standard that requires a 5 times trailing clear margin.
- **GS1 DataBar Limited Security Level 4:** Security level extends beyond the standard required by GS1. This level of security requires a 5 times leading and trailing clear margin.

GS1 DataBar Limited Security Level (continued)



**GS1 DataBar Limited Security Level 1
(1)**



**GS1 DataBar Limited Security Level 2
(2)**

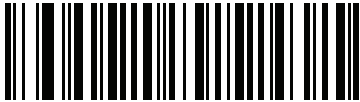

***GS1 DataBar Limited Security Level 3
(3)**

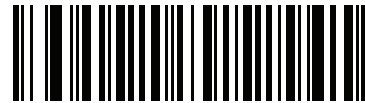

**GS1 DataBar Limited Security Level 4
(4)**

Convert GS1 DataBar to UPC/EAN

Parameter # 397

This parameter only applies to GS1 DataBar-14 and GS1 DataBar Limited symbols not decoded as part of a Composite symbol. Enable this to strip the leading '010' from DataBar-14 and DataBar Limited symbols encoding a single zero as the first digit, and report the bar code as EAN-13.

For bar codes beginning with two or more zeros but not six zeros, this parameter strips the leading '0100' and reports the bar code as UPC-A. The UPC-A Preamble parameter that transmits the system character and country code applies to converted bar codes. Note that neither the system character nor the check digit can be stripped.

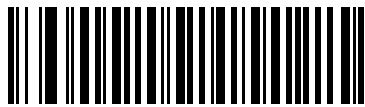

**Enable Convert GS1 DataBar to UPC/EAN
(1)**

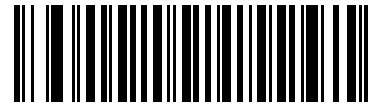

***Disable Convert GS1 DataBar to UPC/EAN
(0)**

Symbology-Specific Security Levels

Redundancy Level (Linear Code Type Security Level)

Parameter # 78

The scanner offers four levels of decode security for linear code types (e.g. Code 39, Interleaved 2 of 5). Select higher security levels for decreasing levels of bar code quality. As security levels increase, the scanner's aggressiveness decreases.

Select the security level appropriate for your bar code quality.

Redundancy Level 1

The following code types must be successfully read twice before being decoded:

Code Type	Length
Codabar	All
MSI	4 or less
D 2 of 5	8 or less
I 2 of 5	8 or less

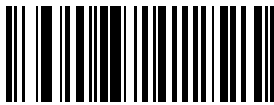

***Redundancy Level 1
(1)**

Redundancy Level 2

All code types must be successfully read twice before being decoded.



**Redundancy Level 2
(2)**

Redundancy Level 3

Code types other than the following must be successfully read twice before being decoded. The following codes must be read three times:

Code Type	Length
MSI	4 or less
D 2 of 5	8 or less
I 2 of 5	8 or less



**Redundancy Level 3
(3)**

Redundancy Level 4

All code types must be successfully read three times before being decoded.



**Redundancy Level 4
(4)**

Bi-directional Redundancy

Parameter # 67

This parameter is only valid when a [Redundancy Level \(Linear Code Type Security Level\) on page 8-68](#) is enabled. When this parameter is enabled, a bar code must be successfully scanned in both directions (forward and reverse) before being decoded.



**Enable Bi-directional Redundancy
(01h)**



***Disable Bi-directional Redundancy
(00h)**

Security Level

Parameter # 77

The scanner offers four levels of decode security for UPC/EAN and Code 93. Select increasing levels of security for decreasing levels of bar code quality. There is an inverse relationship between security and scanner aggressiveness, so choose only that level of security necessary for any given application.

- **Security Level 0:** This setting allows the scanner to operate in its most aggressive state, while providing sufficient security in decoding most “in-spec” bar codes.
- **Security Level 1:** This default setting eliminates most misdecodes.
- **Security Level 2:** Select this option if Security level 1 fails to eliminate misdecodes.
- **Security Level 3:** If you selected Security Level 2 and misdecodes still occur, select this security level. Be advised, selecting this option is an extreme measure against mis-decoding severely out of spec bar codes. Selecting this level of security significantly impairs the decoding ability of the scanner. If you need this level of security, try to improve the quality of the bar codes.

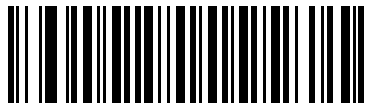

***Security Level 0**
(0)

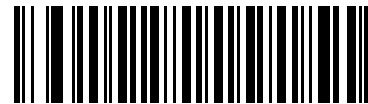

Security Level 1
(1)



Security Level 2
(2)



Security Level 3
(3)

Intercharacter Gap Size

Parameter # 381

The Code 39 and Codabar symbologies have an intercharacter gap that is typically quite small. Due to various bar code-printing technologies, this gap can grow larger than the maximum size allowed, preventing the scanner from decoding the symbol. If this problem occurs, scan the **Large Intercharacter Gaps** parameter to tolerate these out-of-specification bar codes.



***Normal Intercharacter Gaps
(6)**



**Large Intercharacter Gaps
(10)**

CHAPTER 9 123SCAN2

Introduction

123Scan² is an easy-to-use, PC-based software tool that enables rapid and easy customized setup of scanners.

123Scan² uses a wizard tool to guide users through a streamlined set up process. Settings are saved in a configuration file that can be distributed via e-mail, electronically downloaded via a USB cable, or used to generate a sheet of scannable programming bar codes.

Additionally 123Scan² can upgrade scanner firmware, check online to enable support for newly released products, generate a collection of multi-setting bar codes if the number of settings is very large, stage large number of scanners simultaneously, generate reports with asset tracking information and create custom products.

Communication with 123Scan²

To communicate with the 123Scan² program which runs on a host computer running a Windows XP SP3, Windows 7, or Windows 8/8.1 operating system, use a USB cable to connect the scanner to the host computer (see [Connecting a USB Interface on page 3-2](#)).

123Scan² Requirements

- Host computer with Windows XP SP2, or Windows 7
- Scanner
- USB cable.

For more information on 123Scan², go to:
<http://www.zebra.com/123Scan2>

For a 1 minute video tour of 123Scan, go to:
<http://www.zebra.com/scannersoftwarevideos>

To download 123Scan² software and access the Help file integrated in the utility, go to:
<http://www.zebra.com/123Scan2>

Scanner SDK, Other Software Tools, and Videos

Tackle all your scanner programming needs with our diversified set of software tools. Whether you need to simply stage a device, or develop a fully featured application with image and data capture as well as asset management, these tools help you every step of the way. To download any of the free tools listed below, go to:
<http://www.zebra.com/software>.

- 123Scan2 Configuration Utility (described in this chapter)
- Scanner SDK for Windows
- How-to-Videos
- Virtual Com Port Driver
- OPOS Driver
- JPOS Driver
- Scanner User Documentation
- Archive of Older Drivers.

CHAPTER 10 ADVANCED DATA FORMATTING

Introduction

Advanced Data Formatting (ADF) is a means of customizing data before transmission to the host device. Use ADF to edit scan data to suit requirements. Implement ADF by scanning a related series of bar codes which program the imager with ADF rules.

For information and programming bar codes for ADF, refer to the *Advanced Data Formatting Programmer Guide*, p/n 72E-69680-xx.

CHAPTER 11 MAINTENANCE, TROUBLESHOOTING & TECHNICAL SPECIFICATIONS

Introduction

This chapter includes suggested scanner maintenance, troubleshooting, technical specifications, and signal descriptions (pinouts).

Maintenance

Cleaning the exit window is the only maintenance required. A dirty window can affect scanning accuracy.

- Do not allow any abrasive material to touch the window
- Remove any dirt particles with a damp cloth
- Wipe the window using a tissue moistened with ammonia/water
- Do not spray water or other cleaning liquids directly into the window.

Troubleshooting

Table 11-1 *Troubleshooting*

Problem	Possible Causes	Possible Solutions
Nothing happens when you follow the operating instructions, or the scanner displays erratic behavior (laser does not come on, scanner emits frequent beeps).	No power to the scanner.	Check the system power. Ensure the power supply is connected if your configuration requires a power supply.
	Interface/power cables are loose.	Check for loose cable connections.
Laser comes on, but symbol does not decode.	Scanner is not programmed for the correct bar code type.	Be sure the scanner is programmed to read the type of bar code you are scanning.
	Bar code symbol is unreadable.	Check the symbol to make sure it is not defaced. Try scanning test symbols of the same bar code type.
	Distance between scanner and bar code is incorrect.	Move the scanner closer to or further from the bar code.
Symbol is decoded, but not transmitted to the host.	Scanner is not programmed for the correct host type.	Scan the appropriate host type bar code.

Table 11-1 *Troubleshooting (Continued)*

Problem	Possible Causes	Possible Solutions
Scanned data is incorrectly displayed on the host.	Scanner is not programmed to work with the host. Check scanner host type parameters or editing options.	<p>Be sure proper host is selected. (See the host chapter for your scanner.)</p> <p>For RS-232, ensure the scanner's communication parameters match the host's settings.</p> <p>For a USB HID keyboard or a keyboard wedge configuration, ensure the system is programmed for the correct keyboard type and language, and the CAPS LOCK key is in the correct state.</p> <p>Be sure editing options (e.g., ADF, UPC-E to UPC-A Conversion) are properly programmed.</p>



NOTE If after performing these checks the symbol still does not scan, contact your distributor or support. See [page xvi](#) for contact information.

Technical Specifications

Table 11-2 *Technical Specifications*

Item	Description
Power Requirements	Use only a Zebra-approved power supply (p/n PWRS-14000-253R, PWRS-14000-256R, PWRS-14000-257R, or PWRS-14000-258R) output rated 5 VDVC and minimum 650mA. The power supply is certified to EN60950 with SELV outputs. Use of alternative power supply will invalidate any approval given to this device and may be dangerous.
Voltage and Current	5VDC \pm 10% < 175 mA scanning < 90 mA standby < 2.5 mA USB suspend < 4.0 mA low power mode* (when enabled, RS-232 and keyboard wedge only) *(Scanners branded with a silver logo )
Power Source	Depending on host: <ul style="list-style-type: none"> • Host powered • External power supply
Decode Capability	UPC/EAN, UPC/EAN with supplementals, UCC/EAN, JAN 8 & 13, 128, Code 39, Code 39 Full ASCII, Code 39 Trioptic, Codabar (NW7), Interleaved 2 of 5, Discrete 2 of 5, Code 128, Code 93, MSI, Code 11, UCC/EAN, GS1 DataBar, Code 32, Coupon Code, Bookland EAN, IATA
Beeper Operation	User-selectable: Enable, Disable
Beeper Volume	User-selectable: three levels
Beeper Tone	User-selectable: three tones
Scan Repetition Rate	100 \pm 5 scans/second
Yaw Tolerance	\pm 10° from nominal
Pitch Tolerance	\pm 65° from nominal
Roll Tolerance	\pm 60° from nominal
Print Contrast Minimum	20% minimum reflectance differential, measured at 650 nm.
Ambient Light Tolerance	Tolerant to typical artificial indoor and natural outdoor (direct sunlight) lighting conditions. Fluorescent, Incandescent, Mercury Vapor, Sodium Vapor, LED: 450 Ft Candles (4,844 Lux) Sunlight: 8000 Ft Candles (86,111 Lux) Note: LED lighting with high AC ripple content can impact scanning performance.
Durability	5 ft (1.5 m) drops to concrete
Operating Temperature	32° to 120° F (0° to 50° C)
Storage Temperature	-40° to 140° F (-40° to 60° C)
Humidity	5% to 95% (non-condensing)

Table 11-2 *Technical Specifications (Continued)*

Item	Description
Weight (without cable)	5.29 oz. (150 g)
Dimensions: Height Width Depth	6.0 in. (15.2 cm) 2.5in. (6.3 cm) 3.34 in. (8.4 cm)
Laser	650nm laser diode
ESD	15 kV area discharge 8 kV contact discharge
Minimum Element Width	5 mil (0.127 mm)
Interfaces Supported	Decoded: USB, RS-232, IBM 468X/469X, keyboard wedge

Scanner Signal Descriptions

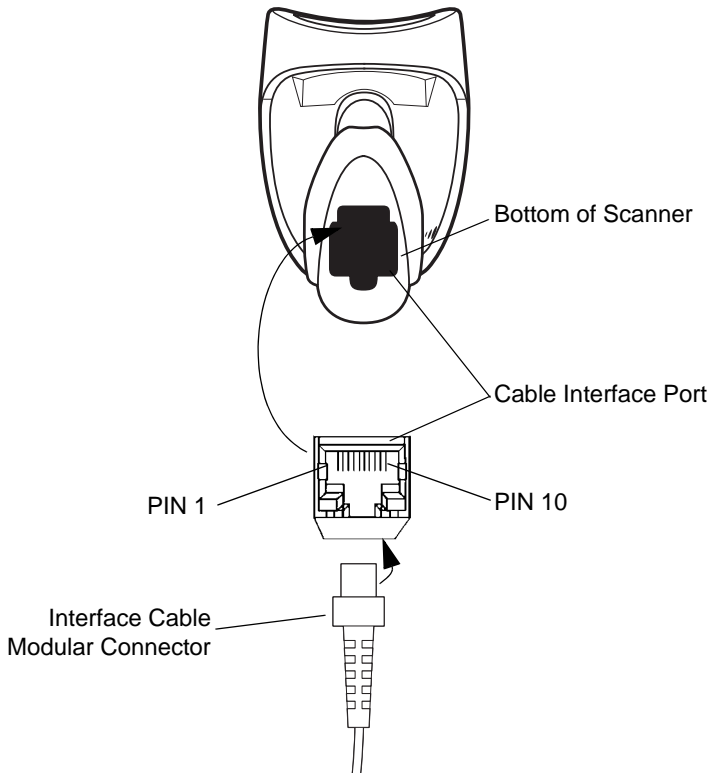

Figure 11-1 Scanner Cable Pinouts

The signal descriptions in [Table 11-3](#) apply to the connector on scanners branded with a silver logo  and are for reference only.

Table 11-3 Scanner Signal Pin-outs

Pin	IBM	RS-232	Keyboard Wedge	USB
1	Cable ID	Cable ID	Cable ID	Cable ID
2	Power	Power	Power	Power
3	Ground	Ground	Ground	Ground
4	IBM_OUT	TxD	KeyClock	Reserved
5	IBM_IN	RxD	TermData	D +
6	IBM_T/R	RTS	KeyData	Reserved
7	Reserved	CTS	TermClock	D -
8	Reserved	Reserved	Reserved	Reserved
9	Reserved	Reserved	Reserved	Reserved
10	Reserved	Reserved	Reserved	Reserved

APPENDIX A STANDARD DEFAULT PARAMETERS

Table A-1 Standard Default Parameters Table

Parameter	Parameter Number	Default	Page Number
USB Host Parameters			
USB Device Type	N/A	USB Keyboard (HID)	3-5
Symbol Native API (SNAPI) Status Handshaking	N/A	Enable	3-6
USB Keystroke Delay	N/A	No Delay	3-7
USB CAPS Lock Override	N/A	Disable	3-7
USB Ignore Unknown Characters	N/A	Send	3-8
USB Convert Unknown to Code 39	N/A	Disable	3-8
Emulate Keypad	N/A	Disable	3-9
Emulate Keypad with Leading Zero	N/A	Disable	3-9
Quick Keypad Emulation	N/A	Disable	3-10
USB FN1 Substitution	N/A	Disable	3-10
Function Key Mapping	N/A	Disable	3-11
Simulated Caps Lock	N/A	Disable	3-11
Convert Case	N/A	No Case Conversion	3-12
USB Polling Interval	N/A	8 msec	3-13
Fast HID Keyboard	N/A	Disable	3-14
USB Static CDC	N/A	Enable	3-15
TGCS (IBM) USB Ignore Beep Directive	N/A	Disable	3-16

¹User selection is required to configure this interface and this is the most common selection.

Table A-1 Standard Default Parameters Table (Continued)

Parameter	Parameter Number	Default	Page Number
TGCS (IBM) USB Ignore Bar Code Configuration Directive	N/A	Disable	3-16
RS-232 Host Parameters			
RS-232 Host Types	N/A	Standard	4-6
Baud Rate	N/A	9600	4-8
Stop Bit Select	N/A	1 Stop Bit	4-9
Data Bits (ASCII Format)	N/A	8-bit	4-10
Parity Type	N/A	None	4-11
Check Receive Errors	N/A	Enable	4-12
Hardware Handshaking	N/A	None	4-12
Software Handshaking	N/A	None	4-14
Host Serial Response Time-out	N/A	2 sec	4-16
RTS Line State	N/A	Low RTS	4-17
Beep on <BEL>	N/A	Disable	4-17
Intercharacter Delay	N/A	0 msec	4-18
Nixdorf Beep/LED Options	N/A	Normal Operation	4-19
Ignore Unknown Characters	N/A	Send Bar Code	4-19
IBM 468X/469X Host Parameters			
Port Address	N/A	None Selected	5-4
Convert Unknown to Code 39	N/A	Disable	5-5
Ignore Beep	N/A	Enable	5-5
Ignore Bar Code Configuration	N/A	Enable	5-6
Keyboard Wedge Host Parameters			
Keyboard Wedge Host Type	N/A	IBM PC/AT & IBM PC Compatibles	6-4
Ignore Unknown Characters	N/A	Send	6-4
Keystroke Delay	N/A	No Delay	6-5
Intra-Keystroke Delay	N/A	Disable	6-5
Alternate Numeric Keypad Emulation	N/A	Disable	6-6
Quick Keypad Emulation	N/A	Disable	6-6

¹User selection is required to configure this interface and this is the most common selection.

Table A-1 Standard Default Parameters Table (Continued)

Parameter	Parameter Number	Default	Page Number
Caps Lock On	N/A	Disable	6-7
Convert Wedge Data	N/A	No Convert	6-8
Caps Lock Override	N/A	Disable	6-7
Function Key Mapping	N/A	Disable	6-8
FN1 Substitution	N/A	Disable	6-9
Send and Make Break	N/A	Send	6-9
User Preferences			
Set Defaults		All Defaults	7-4
Out Of Box Experience	N/A	N/A	7-5
Report Version	N/A	N/A	7-6
Parameter Bar Code Scanning	236	Enable	7-7
Beep After Good Decode	56	Enable	7-7
Direct Decode Indicator	859	Disable	7-8
Suppress Power-up Beeps	721	Do Not Suppress	7-8
Beeper Tone	145	Medium	7-9
Beeper Volume	140	High	7-10
Beeper Duration	628	Medium	7-11
Hand-Held Trigger Mode	138	Standard (Level)	7-12
Hands-Free Trigger Mode	630	Enable	7-13
Power Mode	128	Continuous On	7-14
Time Delay to Low Power Mode	146	1 hour	7-15
Continuous Bar Code Read	649	Disable	7-17
Unique Bar Code Reporting	723	Enable	7-17
Decode Session Timeout	136	3.0 sec	7-18
Time-out Between Same Symbol	137	0.6 sec	7-19
Time-out Between Different Symbols	144	0.2 sec	7-19
Miscellaneous Options			
Transmit Code ID Character	45	None	7-20
Prefix Value	99, 105	7013 <CR><LF>	7-21

¹User selection is required to configure this interface and this is the most common selection.

Table A-1 Standard Default Parameters Table (Continued)

Parameter	Parameter Number	Default	Page Number
Suffix 1 Value	98, 104	7013 <CR><LF>	7-21
Suffix 2 Value	100, 106		
Scan Data Transmission Format	235	Data as is	7-22
FN1 Substitution Values	103, 109	7013 <CR><LF>	7-24
Transmit "No Read" Message	94	Disable	7-25
Unsolicited Heartbeat Interval	1118	Disable	7-26
Enter Key (Carriage Return/Line Feed)	N/A	N/A	7-27
Tab Key	N/A	N/A	7-27
Symbologies			
Disable/Enable All Code Types	N/A	N/A	8-6
UPC/EAN			
UPC-A	1	Enable	8-7
UPC-E	2	Enable	8-7
UPC-E1	12	Disable	8-8
EAN-8/JAN 8	4	Enable	8-8
EAN-13/JAN 13	3	Enable	8-9
Bookland EAN	83	Disable	8-9
Decode UPC/EAN/JAN Supplementals (2 and 5 digits)	16	Ignore	8-10
User-Programmable Supplementals		FFF	8-13
Supplemental 1:	579		
Supplemental 2:	580		
UPC/EAN/JAN Supplemental Redundancy	80	7	8-13
UPC/EAN/JAN Supplemental AIM ID Format	672	Combined	8-14
Transmit UPC-A Check Digit	40	Enable	8-15
Transmit UPC-E Check Digit	41	Enable	8-15
Transmit UPC-E1 Check Digit	42	Enable	8-16
UPC-A Preamble	34	System Character	8-16
UPC-E Preamble	35	System Character	8-17
UPC-E1 Preamble	36	System Character	8-18
Convert UPC-E to A	37	Disable	8-19

¹User selection is required to configure this interface and this is the most common selection.

Table A-1 Standard Default Parameters Table (Continued)

Parameter	Parameter Number	Default	Page Number
Convert UPC-E1 to A	38	Disable	8-19
EAN-8/JAN-8 Extend	39	Disable	8-20
Bookland ISBN Format	576	ISBN-10	8-20
UCC Coupon Extended Code	85	Disable	8-21
Coupon Report	730	Autodiscriminate	8-21
ISSN EAN	617	Disable	8-22
Code 128			
Code 128	8	Enable	8-23
Set Length(s) for Code 128	209, 210	1 to 80	8-23
GS1-128 (formerly UCC/EAN-128)	14	Enable	8-25
ISBT 128	84	Enable	8-25
ISBT Concatenation	577	Autodiscriminate	8-26
Check ISBT Table	578	Enable	8-27
ISBT Concatenation Redundancy	223	10	8-27
Code 128 Security Level	751	Security Level 1	8-28
Code 39			
Code 39	0	Enable	8-29
Trioptic Code 39	13	Disable	8-29
Convert Code 39 to Code 32 (Italian Pharmacy Code)	86	Disable	8-30
Code 32 Prefix	231	Disable	8-30
Set Length(s) for Code 39	18, 19	2 to 55	8-31
Code 39 Check Digit Verification	48	Disable	8-32
Transmit Code 39 Check Digit	43	Disable	8-32
Code 39 Full ASCII Conversion	17	Disable	8-33
Buffer Code 39	113	Disable	8-34
Code 39 Security Level	750	Security Level 1	8-36
Code 93			
Code 93	9	Disable	8-37
Set Length(s) for Code 93	26, 27	4 to 55	8-37

¹User selection is required to configure this interface and this is the most common selection.

Table A-1 Standard Default Parameters Table (Continued)

Parameter	Parameter Number	Default	Page Number
Code 11			
Code 11	10	Disable	8-39
Set Length(s) for Code 11	28, 29	4 to 55	8-39
Code 11 Check Digit Verification	52	Disable	8-41
Transmit Code 11 Check Digit(s)	47	Disable	8-42
Interleaved 2 of 5 (ITF)			
Interleaved 2 of 5 (ITF)	6	Enable	8-43
Set Length(s) for I 2 of 5	22, 23	One discrete length: 14	8-43
I 2 of 5 Check Digit Verification	49	Disable	8-45
Transmit I 2 of 5 Check Digit	44	Disable	8-45
Convert I 2 of 5 to EAN 13	82	Disable	8-46
I 2 of 5 Security Level	1121	1	8-47
Discrete 2 of 5 (DTF)			
Discrete 2 of 5	5	Disable	8-49
Set Length(s) for D 2 of 5	20, 21	One discrete length: 12	8-49
Codabar (NW - 7)			
Codabar	7	Disable	8-51
Set Length(s) for Codabar	24, 25	5 to 55	8-51
CLSI Editing	54	Disable	8-53
NOTIS Editing	55	Disable	8-53
Codabar Upper or Lower Case Start/Stop Characters Transmission	855	Upper Case	8-54
MSI			
MSI	11	Disable	8-55
Set Length(s) for MSI	30, 31	4 to 55	8-55
MSI Check Digits	50	1	8-57
Transmit MSI Check Digit	46	Disable	8-57
MSI Check Digit Algorithm	51	Mod 10/Mod 10	8-58
Chinese 2 of 5			
Enable/Disable Chinese 2 of 5	408	Disable	8-59

¹User selection is required to configure this interface and this is the most common selection.

Table A-1 Standard Default Parameters Table (Continued)

Parameter	Parameter Number	Default	Page Number
Matrix 2 of 5			
Enable/Disable Matrix 2 of 5	618	Disable	8-60
Matrix 2 of 5 Lengths	619, 620	4 to 80	8-60
Matrix 2 of 5 Check Digit	622	Disable	8-62
Transmit Matrix 2 of 5 Check Digit	623	Disable	8-62
Korean 3 of 5			
Korean 3 of 5	581	Disable	8-63
GS1 DataBar			
GS1 DataBar-14	338	Disable	8-64
GS1 DataBar Limited	339	Disable	8-64
GS1 DataBar Expanded	340	Disable	8-65
GS1 DataBar Limited Security Level	728	Level 3	8-65
Convert GS1 DataBar to UPC/EAN	397	Disable	8-67
Symbology-Specific Security Levels			
Redundancy Level (Linear Code Type Security Level)	78	1	8-68
Bi-directional Redundancy	67	Disable	8-70
Security Level	77	0	8-71
Intercharacter Gap Size	381	Normal	8-72
USB & Keyboard Wedge Country Codes			
Country Keyboard Types (Country Codes)	N/A	North American Standard Keyboard	B-1
Country Code Pages	N/A	N/A	C-1

¹User selection is required to configure this interface and this is the most common selection.

APPENDIX B COUNTRY CODES

Introduction

✓ **NOTE** This appendix applies only to scanners branded with a silver logo .

This appendix provides instructions for programming the keyboard to interface with a USB or keyboard wedge host. The host can power the scanner. For host setup information, see [Chapter 3, USB INTERFACE](#) and [Chapter 6, KEYBOARD WEDGE INTERFACE](#).

Throughout the programming bar code menus, default values are indicated with asterisks (*).

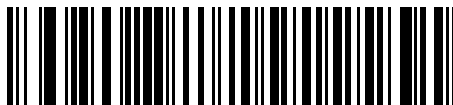

*Indicates Default — *US English (North American) Keyboard — Feature/Option

Country Code Page Defaults

Table B-1 lists the code page default for each country keyboard. Note that these can not be changed. See *USB and Keyboard Wedge Country Keyboard Types (Country Codes)* on page B-6 to select the country keyboard.

- ✓ **NOTE** If the default code page of your selected country code is Windows 1251, Windows 1253, Windows 1255, or Windows 1256, enable *Emulate Keypad* on page 3-9 and *Quick Keypad Emulation* on page 3-10 for USB HID host, or for a keyboard wedge host, enable *Alternate Numeric Keypad Emulation* on page 6-6 and *Quick Keypad Emulation* on page 6-6.

Table B-1 Country Code Page Defaults

Country Keyboard	Code Page Default
US English (North American)	Windows 1252
Albanian	Windows 1250
Arabic 101	Windows 1256
Arabic 102	Windows 1256
Arabic 102 AZERTY	Windows 1256
Azeri Latin	Windows 1254
Azeri Cyrillic	Windows 1251
Belarusian	Windows 1251
Bosnian Latin	Windows 1250
Bosnian Cyrillic	Windows 1251
Bulgarian Latin	Windows 1250
Bulgarian Cyrillic	Windows 1251
Canadian French Win7	Windows 1252
Canadian French (Legacy)	Windows 1252
Canadian Multilingual	Windows 1252
Croatian	Windows 1250
Chinese ASCII	Windows 1252
Czech	Windows 1250
Czech Programmers	Windows 1250
Czech QWERTY	Windows 1250
Danish	Windows 1252
Dutch Netherland	Windows 1252
Estonian	Windows 1257
Faeroese	Windows 1252

Table B-1 Country Code Page Defaults (Continued)

Country Keyboard	Code Page Default
Finnish	Windows 1252
French (France)	Windows 1252
French (Canada) 95/98	Windows 1252
French (Canada) 2000/XP	Windows 1252
French International (Belgian French)	Windows 1252
Galician	Windows 1252
German	Windows 1252
Greek Latin	Windows 1252
Greek220 Latin	Windows 1253
Greek319 Latin	Windows 1252
Greek	Windows 1253
Greek220	Windows 1253
Greek319	Windows 1253
Greek Polytonic	Windows 1253
Hebrew Israel	Windows 1255
Hungarian	Windows 1250
Hungarian_101KEY	Windows 1250
Icelandic	Windows 1252
Irish	Windows 1252
Italian	Windows 1252
Italian_142	Windows 1252
Japanese ASCII	Windows 1252
Kazakh	Windows 1251
Korean ASCII	Windows 1252
Kyrgyz Cyrillic	Windows 1251
Latin America	Windows 1252
Latvian	Windows 1257
Latvian QWERTY	Windows 1257
Lithuanian	Windows 1257
Lithuanian_IBM	Windows 1257
Macedonian -FYROM	Windows 1251

Table B-1 Country Code Page Defaults (Continued)

Country Keyboard	Code Page Default
Maltese_47KEY	Windows 1252
Mongolian-Cyrillic	Windows 1251
Norwegian	Windows 1252
Polish_214	Windows 1250
Polish Programmer	Windows 1250
Portuguese Brazil	Windows 1252
Portuguese Brazilian ABNT	Windows 1252
Portuguese Brazilian ABNT2	Windows 1252
Portuguese Portugal	Windows 1252
Romanian	Windows 1250
Romanian Legacy	Windows 1250
Romanian Standard	Windows 1250
Romanian Programmer	Windows 1250
Russian	Windows 1251
Russian Typewriter	Windows 1251
Serbian Latin	Windows 1250
Serbian Cyrillic	Windows 1251
Slovak	Windows 1250
Slovak QWERTY	Windows 1250
Slovenian	Windows 1250
Spanish	Windows 1252
Spanish Variation	Windows 1252
Swedish	Windows 1252
Swiss French	Windows 1252
Swiss German	Windows 1252
Tatar	Windows 1251
Thai-Kedmanee	Windows 874
Turkish F	Windows 1254
Turkish Q	Windows 1254
Ukrainian	Windows 1251
United Kingdom	Windows 1252

Table B-1 *Country Code Page Defaults (Continued)*

Country Keyboard	Code Page Default
United States	Windows 1252
US Dvorak	Windows 1252
US Dvorak Left Hand	Windows 1252
US Dvorak Right Hand	Windows 1252
US International	Windows 1252
Uzbek Cyrillic	Windows 1251
Vietnamese	Windows 1258

USB and Keyboard Wedge Country Keyboard Types (Country Codes)

Scan the bar code corresponding to the keyboard type. For a USB host, this setting applies only to the USB Keyboard (HID) device. If the keyboard type is not listed, see [Emulate Keypad on page 3-9](#) for the USB HID host. For a Keyboard Wedge host, see [Alternate Numeric Keypad Emulation on page 6-6](#).



NOTE When changing USB country keyboard types the scanner automatically resets. The scanner issues the standard startup beep sequences.



IMPORTANT 1. Some country keyboard bar code types are specific to certain Windows Operating Systems (i.e., XP, and Win 7, or higher). Bar codes requiring a specific Windows OS are noted so in their bar code captions.

2. Use the **French International** bar code for Belgian French keyboards.

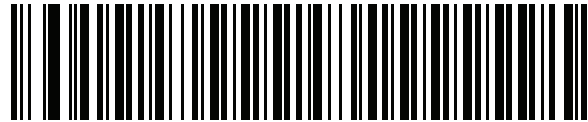

*US English (North American)



Albanian

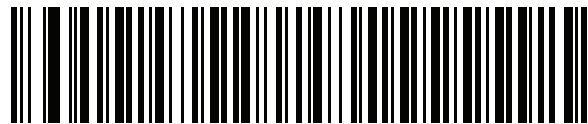

Arabic (101)



Arabic (102)



Arabic (102) AZERTY

Country Codes (Continued)



Azeri (Latin)



Azeri (Cyrillic)



Belarusian



Bosnian (Latin)



Bosnian (Cyrillic)

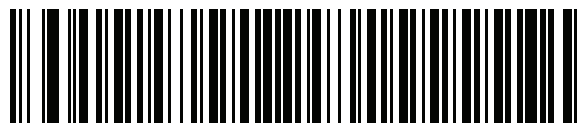

Bulgarian (Latin)

Country Codes (Continued)

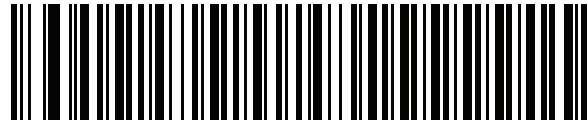

**Bulgarian Cyrillic (Typewriter)
(Bulgarian -Windows XP
Typewriter - Win 7, or higher)**

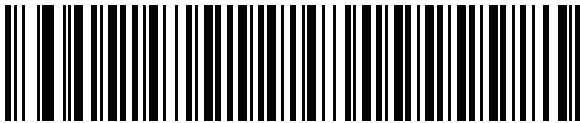

Canadian French Win7

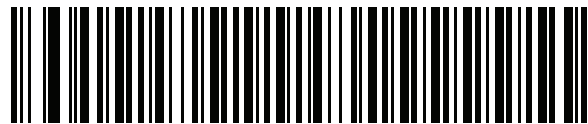

Canadian French (Legacy)

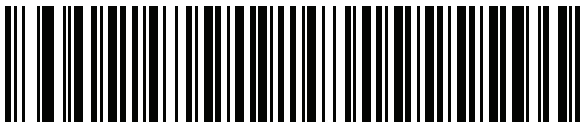

Canadian Multilingual Standard



Chinese (ASCII)

Country Codes (Continued)

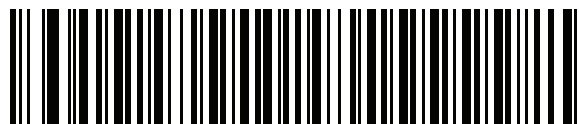

Croatian



Czech



Czech (Programmer)



Czech (QWERTY)



Danish



Dutch (Netherlands)

Country Codes (Continued)



Estonian

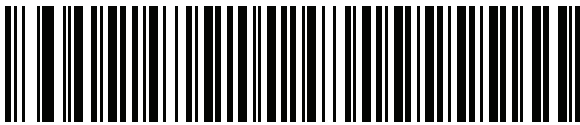

Faeroese

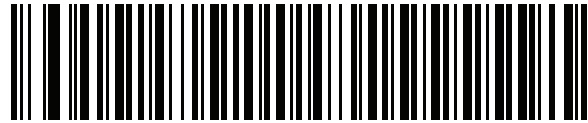

Finnish



French (France)

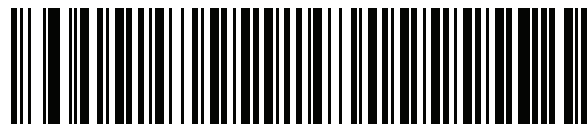

**French International
(Belgian French)**

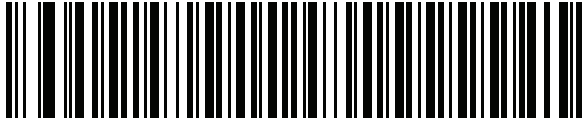

French (Canada) 95/98

Country Codes (Continued)**French (Canada) 2000/XP***

*Note that there is also a country code bar code for [Canadian Multilingual Standard on page B-8](#). Be sure to select the appropriate bar code for your host system.

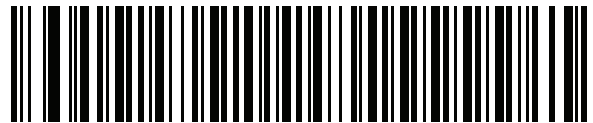
**Galician****German****Greek Latin****Greek (220) Latin****Greek (319) Latin****Greek**

Country Codes (Continued)

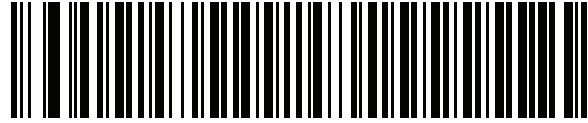

Greek (220)

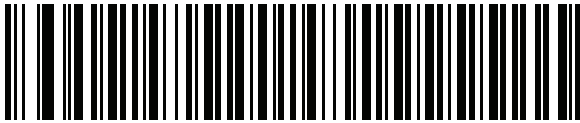

Greek (319)

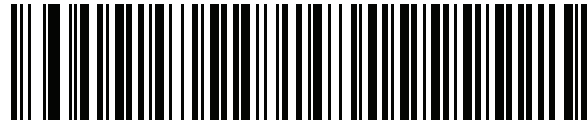

Greek Polytonic

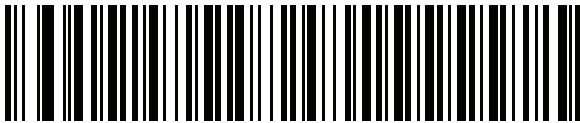

Hebrew Israel

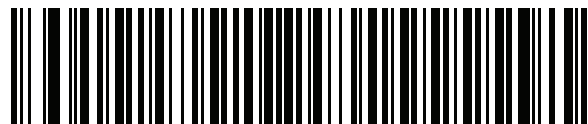

Hungarian



Hungarian_101KEY



Icelandic

Country Codes (Continued)



Irish



Italian



Italian (142)



Japanese (ASCII)



Kazakh



Korean (ASCII)



Kyrgyz

Country Codes (Continued)

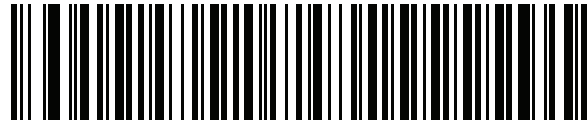

Latin American

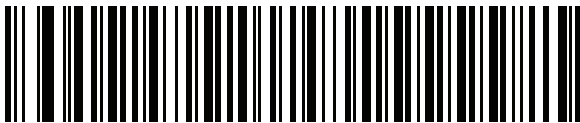

Latvian



Latvian (QWERTY)



Lithuanian

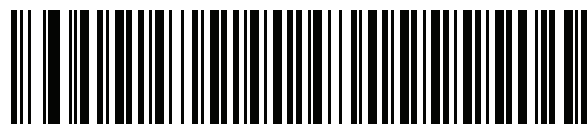

Lithuanian (IBM)



Macedonian (FYROM)



Maltese_47KEY

Country Codes (Continued)

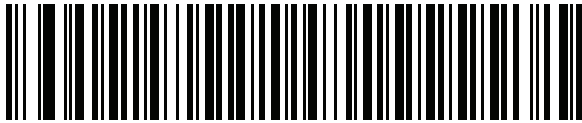

Mongolian



Norwegian

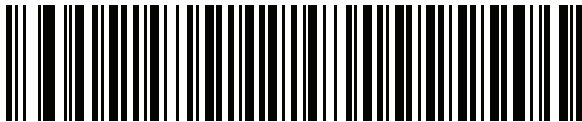

Polish (214)

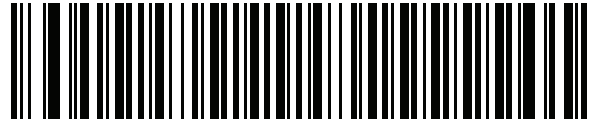

Polish (Programmer)



**Portuguese (Brazil)
(Windows XP)**

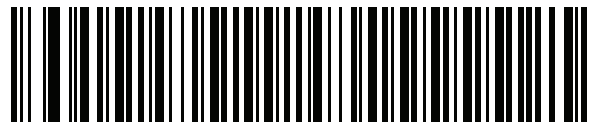

Portuguese (Brazilian ABNT)



Portuguese (Brazilian ABNT2)

Country Codes (Continued)

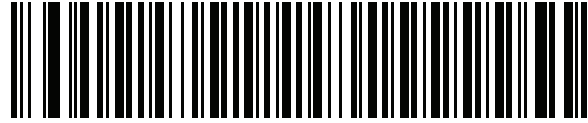

Portuguese (Portugal)

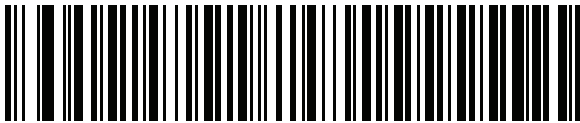

**Romanian
(Windows XP)**

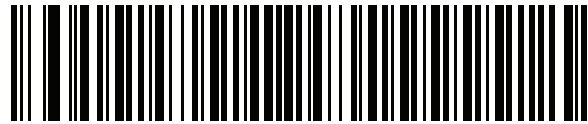

**Romanian (Legacy)
(Win 7, or higher)**

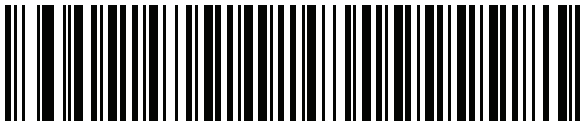

**Romanian (Standard)
(Win 7, or higher)**



**Romanian (Programmer)
(Win 7, or higher)**



Russian

Country Codes (Continued)



Russian (Typewriter)



Serbian (Latin)

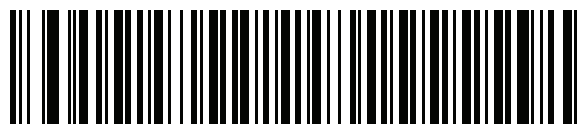

Serbian (Cyrillic)



Slovak



Slovak (QWERTY)



Slovenian

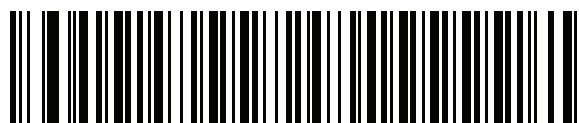

Spanish

Country Codes (Continued)



Spanish (Variation)

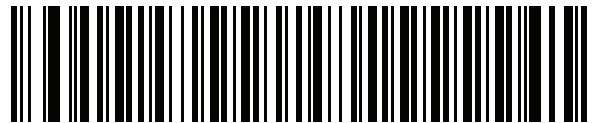

Swedish

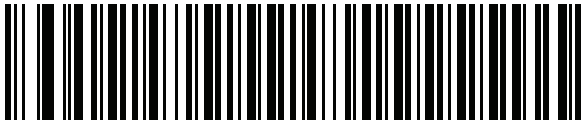

Swiss French



Swiss German



Tatar



Thai (Kedmanee)



Turkish F

Country Codes (Continued)



Turkish Q



UK English

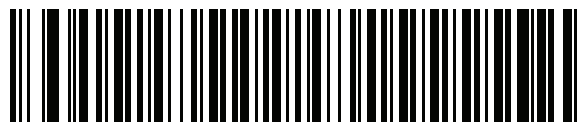

Ukrainian



US Dvorak



US Dvorak Left



US Dvorak Right

Country Codes (Continued)

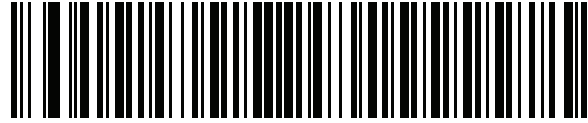

US International

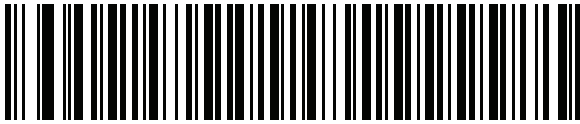

Uzbek

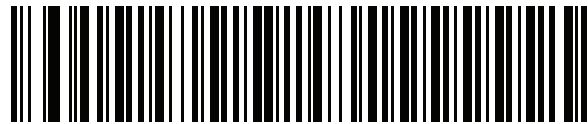

Vietnamese

APPENDIX C PROGRAMMING REFERENCE

Symbol Code Identifiers

Table C-1 *Symbol Code Characters*

Code Character	Code Type
A	UPC-A, UPC-E, UPC-E1, EAN-8, EAN-13
B	Code 39, Code 32
C	Codabar
D	Code 128, ISBT 128, ISBT 128 Concatenated
E	Code 93
F	Interleaved 2 of 5
G	Discrete 2 of 5, or Discrete 2 of 5 IATA
H	Code 11
J	MSI
K	GS1-128
L	Bookland EAN
M	Trioptic Code 39
N	Coupon Code
R	GS1 DataBar Family
S	Matrix 2 of 5

Table C-1 *Symbol Code Characters (Continued)*

Code Character	Code Type
U	Chinese 2 of 5
V	Korean 3 of 5
X	ISSN EAN

AIM Code Identifiers

Each AIM Code Identifier contains the three-character string **jcm** where:

- j = Flag Character (ASCII 93)
- c = Code Character (see [Table C-2](#))
- m = Modifier Character (see [Table C-3](#))

Table C-2 *Aim Code Characters*

Code Character	Code Type
A	Code 39, Code 39 Full ASCII, Code 32
C	Code 128, ISBT 128, ISBT 128 Concatenated, GS1-128, Coupon (Code 128 portion)
E	UPC/EAN, Coupon (UPC portion)
e	GS1 DataBar Family
F	Codabar
G	Code 93
H	Code 11
I	Interleaved 2 of 5
M	MSI
S	Discrete 2 of 5, IATA 2 of 5
X	Bookland EAN, ISSN EAN, Trioptic Code 39, Chinese 2 of 5, Matrix 2 of 5, Korean 3 of 5

The modifier character is the sum of the applicable option values based on [Table C-3](#)

Table C-3 *Modifier Characters*

Code Type	Option Value	Option
Code 39	0	No check character or Full ASCII processing.
	1	Reader has checked one check character.
	3	Reader has checked and stripped check character.
	4	Reader has performed Full ASCII character conversion.
	5	Reader has performed Full ASCII character conversion and checked one check character.
	7	Reader has performed Full ASCII character conversion and checked and stripped check character.
	Example: A Full ASCII bar code with check character W, A+I+MI+DW , is transmitted as JA7AIMID where $7 = (3+4)$.	
Trioptic Code 39	0	No option specified at this time. Always transmit 0.
	Example: A Trioptic bar code 412356 is transmitted as JX0412356	
Code 128	0	Standard data packet, no Function code 1 in first symbol position.
	1	Function code 1 in first symbol character position.
	2	Function code 1 in second symbol character position.
	Example: A Code (EAN) 128 bar code with Function 1 character ^{FNC1} in the first position, AIMID is transmitted as JC1AIMID	
I 2 of 5	0	No check digit processing.
	1	Reader has validated check digit.
	3	Reader has validated and stripped check digit.
	Example: An I 2 of 5 bar code without check digit, 4123, is transmitted as JIO4123	
Codabar	0	No check digit processing.
	1	Reader has checked check digit.
	3	Reader has stripped check digit before transmission.
	Example: A Codabar bar code without check digit, 4123, is transmitted as JF04123	
Code 93	0	No options specified at this time. Always transmit 0.
	Example: A Code 93 bar code 012345678905 is transmitted as JG0012345678905	
MSI	0	Check digits are sent.
	1	No check digit is sent.
	Example: An MSI bar code 4123, with a single check digit checked, is transmitted as JM14123	

Table C-3 *Modifier Characters (Continued)*

Code Type	Option Value	Option
D 2 of 5	0	No options specified at this time. Always transmit 0.
	Example: A D 2 of 5 bar code 4123, is transmitted as JS04123	
UPC/EAN	0	Standard data packet in full EAN format, i.e. 13 digits for UPC-A, UPC-E, and EAN-13 (not including supplemental data).
	1	Two digit supplemental data only.
	2	Five digit supplemental data only.
	3	Combined data packet comprising 13 digits from EAN-13, UPC-A or UPC-E symbol and 2 or 5 digits from supplemental symbol.
	4	EAN-8 data packet.
	Example: A UPC-A bar code 012345678905 is transmitted as JE00012345678905	
Bookland EAN	0	No options specified at this time. Always transmit 0.
	Example: A Bookland EAN bar code 123456789X is transmitted as JX0123456789X	
ISSN EAN	0	No options specified at this time. Always transmit 0.
	Example: An ISSN EAN bar code 123456789X is transmitted as JX0123456789X	
Code 11	0	Single check digit
	1	Two check digits
	3	Check characters validated but not transmitted.
GS1 DataBar Family		No option specified at this time. Always transmit 0. GS1 DataBar-14 and GS1 DataBar Limited transmit with an Application Identifier "01". Note: In GS1-128 emulation mode, GS1 DataBar is transmitted using Code 128 rules (i.e., JC1).
	Example: A GS1 DataBar-14 bar code 0110012345678902 is transmitted as Je00110012345678902 .	

APPENDIX D SAMPLE BAR CODES

Code 39



UPC/EAN

UPC-A, 100%



EAN-13, 100%



Code 128



Interleaved 2 of 5



GS1 DataBar

✓ **NOTE** GS1 DataBar variants must be enabled to read the bar codes below (see [GS1 DataBar on page 8-64](#)).



10293847560192837465019283746029478450366523
(GS1 DataBar Expanded Stacked)



1234890hjio9900mnb
(GS1 DataBar Expanded)



08672345650916
(GS1 DataBar Limited)

GS1 DataBar-14



55432198673467
(GS1 DataBar-14 Truncated)



90876523412674
(GS1 DataBar-14 Stacked)

APPENDIX E NUMERIC BAR CODES

Numeric Bar Codes

For parameters requiring specific numeric values, scan the appropriately numbered bar code(s).

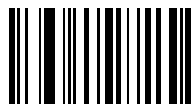

0



1

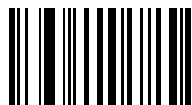

2



3



4



5



6



7



8



9

Cancel

To correct an error or change a selection, scan the bar code below.



Cancel

APPENDIX F ALPHANUMERIC BAR CODES

Alphanumeric Keyboard



Space



#

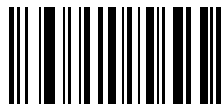

\$



%

Alphanumeric Keyboard (continued)



*

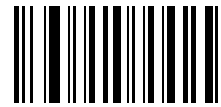

+

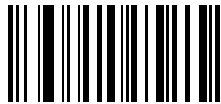

-

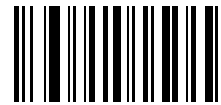

.

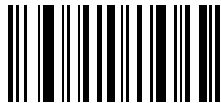

/

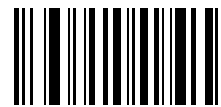

!

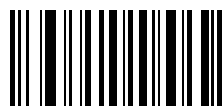
Alphanumeric Keyboard (continued)

"



&

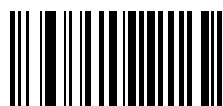

'



(

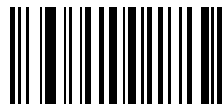

)



:

Alphanumeric Keyboard (continued)



;

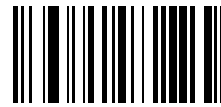

<



=



>



?

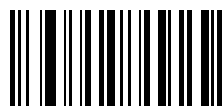

@

Alphanumeric Keyboard (continued)

[



\



]

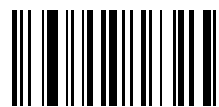

_

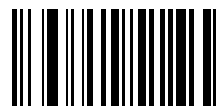

~

Alphanumeric Keyboard (continued)

✓ **NOTE** The bar codes that follow should not be confused with those on the numeric keypad.

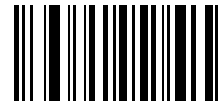

0



1

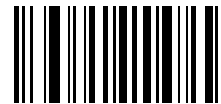

2



3



4



5

Alphanumeric Keyboard (continued)



6

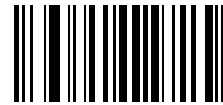

7

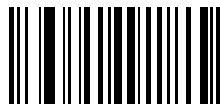

8



9



End of Message



Cancel

Alphanumeric Keyboard (continued)



A

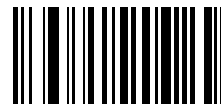

B



C

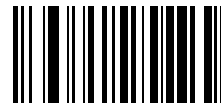

D



E

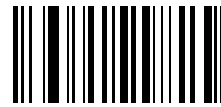

F

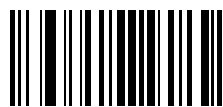
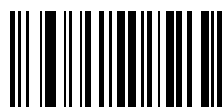
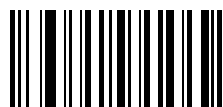
Alphanumeric Keyboard (continued)**G****H****I****J****K****L**

Alphanumeric Keyboard (continued)



M



N



O

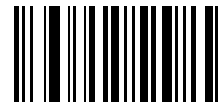

P

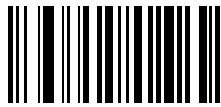

Q

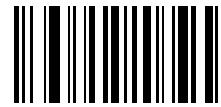

R

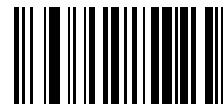
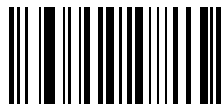
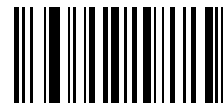
Alphanumeric Keyboard (continued)**S****T****U****V****W****X**

Alphanumeric Keyboard (continued)



Y



Z

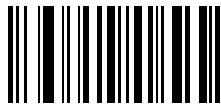

a

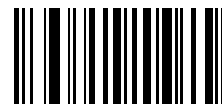

b

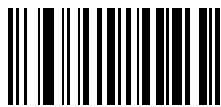

c

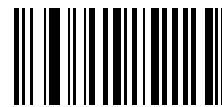

d

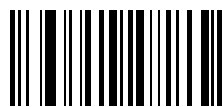
Alphanumeric Keyboard (continued)

e



f

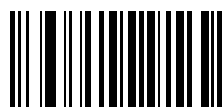

g



h



i



j

Alphanumeric Keyboard (continued)



k

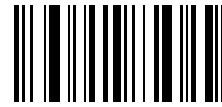

l

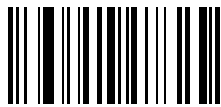

m



n



o

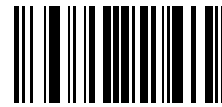

p

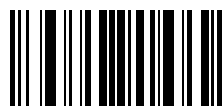
Alphanumeric Keyboard (continued)

q



r

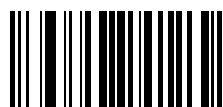

s



t

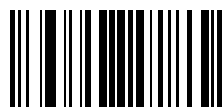

u



v

Alphanumeric Keyboard (continued)



w

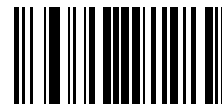

x

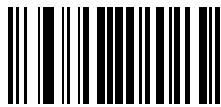

y

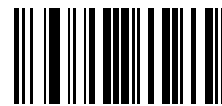

z

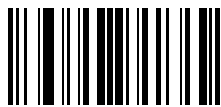

{

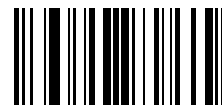

|

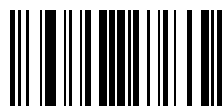
Alphanumeric Keyboard (continued)

}



~

APPENDIX G ASCII CHARACTER SETS

Table G-1 *ASCII Value Table*

ASCII Value	Full ASCII Code 39 Encode Character	Keystroke
1000	%U	CTRL 2
1001	\$A	CTRL A
1002	\$B	CTRL B
1003	\$C	CTRL C
1004	\$D	CTRL D
1005	\$E	CTRL E
1006	\$F	CTRL F
1007	\$G	CTRL G
1008	\$H	CTRL H/ BACKSPACE ¹
1009	\$I	CTRL I/ HORIZONTAL TAB ¹
1010	\$J	CTRL J
1011	\$K	CTRL K
1012	\$L	CTRL L
1013	\$M	CTRL M/ ENTER ¹
1014	\$N	CTRL N
1015	\$O	CTRL O

The keystroke in bold is sent only if the “Function Key Mapping” is enabled. Otherwise, the non-bold keystroke is sent.

Table G-1 ASCII Value Table (Continued)

ASCII Value	Full ASCII Code 39 Encode Character	Keystroke
1016	\$P	CTRL P
1017	\$Q	CTRL Q
1018	\$R	CTRL R
1019	\$S	CTRL S
1020	\$T	CTRL T
1021	\$U	CTRL U
1022	\$V	CTRL V
1023	\$W	CTRL W
1024	\$X	CTRL X
1025	\$Y	CTRL Y
1026	\$Z	CTRL Z
1027	%A	CTRL [
1028	%B	CTRL \
1029	%C	CTRL]
1030	%D	CTRL 6
1031	%E	CTRL -
1032	Space	Space
1033	/A	!
1034	/B	"
1035	/C	#
1036	/D	\$
1037	/E	%
1038	/F	&
1039	/G	'
1040	/H	(
1041	/I)
1042	/J	*
1043	/K	+
1044	/L	,

The keystroke in bold is sent only if the "Function Key Mapping" is enabled. Otherwise, the non-bold keystroke is sent.

Table G-1 ASCII Value Table (Continued)

ASCII Value	Full ASCII Code 39 Encode Character	Keystroke
1045	-	-
1046	.	.
1047	/o	/
1048	0	0
1049	1	1
1050	2	2
1051	3	3
1052	4	4
1053	5	5
1054	6	6
1055	7	7
1056	8	8
1057	9	9
1058	/Z	:
1059	%F	;
1060	%G	<
1061	%H	=
1062	%I	>
1063	%J	?
1064	%V	@
1065	A	A
1066	B	B
1067	C	C
1068	D	D
1069	E	E
1070	F	F
1071	G	G
1072	H	H
1073	I	I

The keystroke in bold is sent only if the "Function Key Mapping" is enabled. Otherwise, the non-bold keystroke is sent.

Table G-1 ASCII Value Table (Continued)

ASCII Value	Full ASCII Code 39 Encode Character	Keystroke
1074	J	J
1075	K	K
1076	L	L
1077	M	M
1078	N	N
1079	O	O
1080	P	P
1081	Q	Q
1082	R	R
1083	S	S
1084	T	T
1085	U	U
1086	V	V
1087	W	W
1088	X	X
1089	Y	Y
1090	Z	Z
1091	%K	[
1092	%L	\
1093	%M]
1094	%N	^
1095	%O	_
1096	%W	'
1097	+A	a
1098	+B	b
1099	+C	c
1100	+D	d
1101	+E	e
1102	+F	f

The keystroke in bold is sent only if the "Function Key Mapping" is enabled. Otherwise, the non-bold keystroke is sent.

Table G-1 ASCII Value Table (Continued)

ASCII Value	Full ASCII Code 39 Encode Character	Keystroke
1103	+G	g
1104	+H	h
1105	+I	i
1106	+J	j
1107	+K	k
1108	+L	l
1109	+M	m
1110	+N	n
1111	+O	o
1112	+P	p
1113	+Q	q
1114	+R	r
1115	+S	s
1116	+T	t
1117	+U	u
1118	+V	v
1119	+W	w
1120	+X	x
1121	+Y	y
1122	+Z	z
1123	%P	{
1124	%Q	
1125	%R	}
1126	%S	~

The keystroke in bold is sent only if the “Function Key Mapping” is enabled. Otherwise, the non-bold keystroke is sent.

Table G-2 *ALT Key Standard Default Tables*

ALT Keys	Keystroke
2064	ALT 2
2065	ALT A
2066	ALT B
2067	ALT C
2068	ALT D
2069	ALT E
2070	ALT F
2071	ALT G
2072	ALT H
2073	ALT I
2074	ALT J
2075	ALT K
2076	ALT L
2077	ALT M
2078	ALT N
2079	ALT O
2080	ALT P
2081	ALT Q
2082	ALT R
2083	ALT S
2084	ALT T
2085	ALT U
2086	ALT V
2087	ALT W
2088	ALT X
2089	ALT Y
2090	ALT Z

Table G-3 *Misc. Key Standard Default Table*

Misc. Key	Keystroke
3001	PA 1
3002	PA 2
3003	CMD 1
3004	CMD 2
3005	CMD 3
3006	CMD 4
3007	CMD 5
3008	CMD 6
3009	CMD 7
3010	CMD 8
3011	CMD 9
3012	CMD 10
3013	CMD 11
3014	CMD 12
3015	CMD 13
3016	CMD 14

Table G-4 *GUI Shift Keys*

Other Value	Keystroke
3048	GUI 0
3049	GUI 1
3050	GUI 2
3051	GUI 3
3052	GUI 4
3053	GUI 5
3054	GUI 6
3055	GUI 7
3056	GUI 8
3057	GUI 9

The Apple™ iMac keyboard has an apple key on either side of the space bar. Windows-based systems have a GUI key to the left of the left ALT key, and to the right of the right ALT key.

Table G-4 GUI Shift Keys (Continued)

Other Value	Keystroke
3065	GUI A
3066	GUI B
3067	GUI C
3068	GUI D
3069	GUI E
3070	GUI F
3071	GUI G
3072	GUI H
3073	GUI I
3074	GUI J
3075	GUI K
3076	GUI L
3077	GUI M
3078	GUI N
3079	GUI O
3080	GUI P
3081	GUI Q
3082	GUI R
3083	GUI S
3084	GUI T
3085	GUI U
3086	GUI V
3087	GUI W
3088	GUI X
3089	GUI Y
3090	GUI Z

The Apple™ iMac keyboard has an apple key on either side of the space bar. Windows-based systems have a GUI key to the left of the left ALT key, and to the right of the right ALT key.

Table G-5 *PF Key Standard Default Table*

PF Keys	Keystroke
4001	PF 1
4002	PF 2
4003	PF 3
4004	PF 4
4005	PF 5
4006	PF 6
4007	PF 7
4008	PF 8
4009	PF 9
4010	PF 10
4011	PF 11
4012	PF 12
4013	PF 13
4014	PF 14
4015	PF 15
4016	PF 16

Table G-6 *F key Standard Default Table*

F Keys	Keystroke
5001	F 1
5002	F 2
5003	F 3
5004	F 4
5005	F 5
5006	F 6
5007	F 7
5008	F 8
5009	F 9
5010	F 10
5011	F 11

Table G-6 *F key Standard Default Table (Continued)*

F Keys	Keystroke
5012	F 12
5013	F 13
5014	F 14
5015	F 15
5016	F 16
5017	F 17
5018	F 18
5019	F 19
5020	F 20
5021	F 21
5022	F 22
5023	F 23
5024	F 24

Table G-7 *Numeric Key Standard Default Table*

Numeric Keypad	Keystroke
6042	*
6043	+
6044	Undefined
6045	-
6046	.
6047	/
6048	0
6049	1
6050	2
6051	3
6052	4
6053	5
6054	6
6055	7
6056	8

Table G-7 *Numeric Key Standard Default Table (Continued)*

Numeric Keypad	Keystroke
6057	9
6058	Enter
6059	Num Lock

Table G-8 *Extended Keypad Standard Default Table*

Extended Keypad	Keystroke
7001	Break
7002	Delete
7003	Pg Up
7004	End
7005	Pg Dn
7006	Pause
7007	Scroll Lock
7008	Backspace
7009	Tab
7010	Print Screen
7011	Insert
7012	Home
7013	Enter
7014	Escape
7015	Up Arrow
7016	Dn Arrow
7017	Left Arrow
7018	Right Arrow

GLOSSARY

A

Aperture. The opening in an optical system defined by a lens or baffle that establishes the field of view.

API. An interface by means of which one software component communicates with or controls another. Usually used to refer to services provided by one software component to another, usually via software interrupts or function calls

Application Programming Interface. See **API**.

ASCII. American Standard Code for Information Interchange. A 7 bit-plus-parity code representing 128 letters, numerals, punctuation marks and control characters. It is a standard data transmission code in the U.S.

Autodiscrimination. The ability of an interface controller to determine the code type of a scanned bar code. After this determination is made, the information content is decoded.

B

Bar. The dark element in a printed bar code symbol.

Bar Code. A pattern of variable-width bars and spaces which represents numeric or alphanumeric data in machine-readable form. The general format of a bar code symbol consists of a leading margin, start character, data or message character, check character (if any), stop character, and trailing margin. Within this framework, each recognizable symbology uses its own unique format. See **Symbology**.

Bar Code Density. The number of characters represented per unit of measurement (e.g., characters per inch).

Bar Height. The dimension of a bar measured perpendicular to the bar width.

Bar Width. Thickness of a bar measured from the edge closest to the symbol start character to the trailing edge of the same bar.

BIOS. Basic Input Output System. A collection of ROM-based code with a standard API used to interface with standard PC hardware.

Bit. Binary digit. One bit is the basic unit of binary information. Generally, eight consecutive bits compose one byte of data. The pattern of 0 and 1 values within the byte determines its meaning.

Bits per Second (bps). Bits transmitted or received.

Boot or Boot-up. The process a computer goes through when it starts. During boot-up, the computer can run self-diagnostic tests and configure hardware and software.

BOOTP. A protocol for remote booting of diskless devices. Assigns an IP address to a machine and may specify a boot file. The client sends a bootp request as a broadcast to the bootp server port (67) and the bootp server responds using the bootp client port (68). The bootp server must have a table of all devices, associated MAC addresses and IP addresses.

bps. See **Bits Per Second**.

Byte. On an addressable boundary, eight adjacent binary digits (0 and 1) combined in a pattern to represent a specific character or numeric value. Bits are numbered from the right, 0 through 7, with bit 0 the low-order bit. One byte in memory is used to store one ASCII character.

C

CDRH. Center for Devices and Radiological Health. A federal agency responsible for regulating laser product safety. This agency specifies various laser operation classes based on power output during operation.

CDRH Class 1. This is the lowest power CDRH laser classification. This class is considered intrinsically safe, even if all laser output were directed into the eye's pupil. There are no special operating procedures for this class.

CDRH Class 2. No additional software mechanisms are needed to conform to this limit. Laser operation in this class poses no danger for unintentional direct human exposure.

Character. A pattern of bars and spaces which either directly represents data or indicates a control function, such as a number, letter, punctuation mark, or communications control contained in a message.

Character Set. Those characters available for encoding in a particular bar code symbology.

Check Digit. A digit used to verify a correct symbol decode. The scanner inserts the decoded data into an arithmetic formula and checks that the resulting number matches the encoded check digit. Check digits are required for UPC but are optional for other symbologies. Using check digits decreases the chance of substitution errors when a symbol is decoded.

Codabar. A discrete self-checking code with a character set consisting of digits 0 to 9 and six additional characters: (- \$: / , +).

Code 128. A high density symbology which allows the controller to encode all 128 ASCII characters without adding extra symbol elements.

Code 3 of 9 (Code 39). A versatile and widely used alphanumeric bar code symbology with a set of 43 character types, including all uppercase letters, numerals from 0 to 9 and 7 special characters (- . / + % \$ and space). The code name is derived from the fact that 3 of 9 elements representing a character are wide, while the remaining 6 are narrow.

Code 93. An industrial symbology compatible with Code 39 but offering a full character ASCII set and a higher coding density than Code 39.

Code Length. Number of data characters in a bar code between the start and stop characters, not including those characters.

Cold Boot. A cold boot restarts the mobile computer and erases all user stored records and entries.

COM port. Communication port; ports are identified by number, e.g., COM1, COM2.

Continuous Code. A bar code or symbol in which all spaces within the symbol are parts of characters. There are no intercharacter gaps in a continuous code. The absence of gaps allows for greater information density.

Cradle. A cradle is used for charging the battery and for communicating with a host computer, and provides a storage place for the terminal when not in use.

D

Dead Zone. An area within a scanner's field of view, in which specular reflection may prevent a successful decode.

Decode. To recognize a bar code symbology (e.g., UPC/EAN) and then analyze the content of the specific bar code scanned.

Decode Algorithm. A decoding scheme that converts pulse widths into data representation of the letters or numbers encoded within a bar code symbol.

Decryption. Decryption is the decoding and unscrambling of received encrypted data. Also see, **Encryption** and **Key**.

Depth of Field. The range between minimum and maximum distances at which a scanner can read a symbol with a certain minimum element width.

Discrete 2 of 5. A binary bar code symbology representing each character by a group of five bars, two of which are wide. The location of wide bars in the group determines which character is encoded; spaces are insignificant. Only numeric characters (0 to 9) and START/STOP characters may be encoded.

Discrete Code. A bar code or symbol in which the spaces between characters (intercharacter gaps) are not part of the code.

DRAM. Dynamic random access memory.

E

EAN. European Article Number. This European/International version of the UPC provides its own coding format and symbology standards. Element dimensions are specified metrically. EAN is used primarily in retail.

Element. Generic term for a bar or space.

Encoded Area. Total linear dimension occupied by all characters of a code pattern, including start/stop characters and data.

ENQ (RS-232). ENQ software handshaking is also supported for the data sent to the host.

ESD. Electro-Static Discharge

F

Flash Disk. An additional megabyte of non-volatile memory for storing application and configuration files.

Flash Memory. Flash memory is responsible for storing the system firmware and is non-volatile. If the system power is interrupted the data is not be lost.

FTP. See **File Transfer Protocol**.

H

Hard Reset. See **Cold Boot**.

Host Computer. A computer that serves other terminals in a network, providing such services as computation, database access, supervisory programs and network control.

Hz. Hertz; A unit of frequency equal to one cycle per second.

I

IDE. Intelligent drive electronics. Refers to the solid-state hard drive type.

IEC. International Electrotechnical Commission. This international agency regulates laser safety by specifying various laser operation classes based on power output during operation.

IEC60825-1 Class 1. This is the lowest power IEC laser classification. Conformity is ensured through a software restriction of 120 seconds of laser operation within any 1000 second window and an automatic laser shutdown if the scanner's oscillating mirror fails.

IEEE Address. See **MAC Address**.

Input/Output Ports. I/O ports are primarily dedicated to passing information into or out of the terminal's memory. Series 9000 mobile computers include Serial and USB ports.

Intellistand. The Intellistand holds a scanner to use in hands-free mode. When a scanner is seated correctly in the stand "cup," the scanner's built-in sensor places the scanner in hands-free mode to automatically decode bar codes moved into the scan area. When you remove the scanner from the stand it operates in its normal hand-held mode.

Intercharacter Gap. The space between two adjacent bar code characters in a discrete code.

Interleaved 2 of 5. A binary bar code symbology representing character pairs in groups of five bars and five interleaved spaces. Interleaving provides for greater information density. The location of wide elements (bar/spaces) within each group determines which characters are encoded. This continuous code type uses no intercharacter spaces. Only numeric (0 to 9) and START/STOP characters may be encoded.

Interleaved Bar Code. A bar code in which characters are paired together, using bars to represent the first character and the intervening spaces to represent the second.

Interleaved 2 of 5. A binary bar code symbology representing character pairs in groups of five bars and five interleaved spaces. Interleaving provides for greater information density. The location of wide elements (bar/spaces) within

each group determines which characters are encoded. This continuous code type uses no intercharacter spaces. Only numeric (0 to 9) and START/STOP characters may be encoded.

I/O Ports. interface The connection between two devices, defined by common physical characteristics, signal characteristics, and signal meanings. Types of interfaces include RS-232 and PCMCIA.

IOCTL. Input/Output Control.

IP Address. (Internet Protocol address) The address of a computer attached to an IP network. Every client and server station must have a unique IP address. A 32-bit address used by a computer on a IP network. Client workstations have either a permanent address or one that is dynamically assigned to them each session. IP addresses are written as four sets of numbers separated by periods; for example, 204.171.64.2.

IPX/SPX. Internet Package Exchange/Sequential Packet Exchange. A communications protocol for Novell. IPX is Novell's Layer 3 protocol, similar to XNS and IP, and used in NetWare networks. SPX is Novell's version of the Xerox SPP protocol.

IS-95. Interim Standard 95. The EIA/TIA standard that governs the operation of CDMA cellular service. Versions include IS-95A and IS-95B. See CDMA.

K

Key. A key is the specific code used by the algorithm to encrypt or decrypt the data. Also see, **Encryption** and **Decrypting**.

L

LASER. Light Amplification by Stimulated Emission of Radiation. The laser is an intense light source. Light from a laser is all the same frequency, unlike the output of an incandescent bulb. Laser light is typically coherent and has a high energy density.

Laser Diode. A gallium-arsenide semiconductor type of laser connected to a power source to generate a laser beam. This laser type is a compact source of coherent light.

Laser Scanner. A type of bar code reader that uses a beam of laser light.

LCD. See **Liquid Crystal Display**.

LED Indicator. A semiconductor diode (LED - Light Emitting Diode) used as an indicator, often in digital displays. The semiconductor uses applied voltage to produce light of a certain frequency determined by the semiconductor's particular chemical composition.

Light Emitting Diode. See **LED**.

Liquid Crystal Display (LCD). A display that uses liquid crystal sealed between two glass plates. The crystals are excited by precise electrical charges, causing them to reflect light outside according to their bias. They use little electricity and react relatively quickly. They require external light to reflect their information to the user.

M

MIL. 1 mil = 1 thousandth of an inch.

Misread (Misdecode). A condition which occurs when the data output of a reader or interface controller does not agree with the data encoded within a bar code symbol.

N

Nominal. The exact (or ideal) intended value for a specified parameter. Tolerances are specified as positive and negative deviations from this value.

Nominal Size. Standard size for a bar code symbol. Most UPC/EAN codes are used over a range of magnifications (e.g., from 0.80 to 2.00 of nominal).

NVM. Non-Volatile Memory.

O

ODI. See **Open Data-Link Interface**.

Open Data-Link Interface (ODI). Novell's driver specification for an interface between network hardware and higher-level protocols. It supports multiple protocols on a single NIC (Network Interface Controller). It is capable of understanding and translating any network information or request sent by any other ODI-compatible protocol into something a NetWare client can understand and process.

Open System Authentication. Open System authentication is a null authentication algorithm.

P

Parameter. A variable that can have different values assigned to it.

PC Card. A plug-in expansion card for laptop computers and other devices, also called a PCMCIA card. PC Cards are 85.6mm long x 54 mm wide, and have a 68 pin connector. There are several different kinds:

- Type I; 3.3 mm high; use - RAM or Flash RAM
- Type II; 5 mm high; use - modems, LAN adaptors
- Type III; 10.5 mm high; use - Hard Disks

PCMCIA. Personal Computer Memory Card Interface Association. See **PC Card**.

Percent Decode. The average probability that a single scan of a bar code would result in a successful decode. In a well-designed bar code scanning system, that probability should approach near 100%.

PING. (Packet Internet Groper) An Internet utility used to determine whether a particular IP address is online. It is used to test and debug a network by sending out a packet and waiting for a response.

Presentation Mode. Typically used when the digital scanner sits on a counter top or is mounted on a wall, in this mode, the digital scanner operates in continuous (constant-on) mode, where it automatically decodes a bar code presented in its field of view.

Print Contrast Signal (PCS). Measurement of the contrast (brightness difference) between the bars and spaces of a symbol. A minimum PCS value is needed for a bar code symbol to be scannable. $PCS = (RL - RD) / RL$, where RL is the reflectance factor of the background and RD the reflectance factor of the dark bars.

Programming Mode. The state in which a scanner is configured for parameter values. See **Scanning Mode**.

Q

Quiet Zone. A clear space, containing no dark marks, which precedes the start character of a bar code symbol and follows the stop character.

QWERTY. A standard keyboard commonly used on North American and some European PC keyboards. "QWERTY" refers to the arrangement of keys on the left side of the third row of keys.

R

RAM. Random Access Memory. Data in RAM can be accessed in random order, and quickly written and read.

Reflectance. Amount of light returned from an illuminated surface.

Resolution. The narrowest element dimension which is distinguished by a particular reading device or printed with a particular device or method.

RF. Radio Frequency.

ROM. Read-Only Memory. Data stored in ROM cannot be changed or removed.

Router. A device that connects networks and supports the required protocols for packet filtering. Routers are typically used to extend the range of cabling and to organize the topology of a network into subnets. See **Subnet**.

RS-232. An Electronic Industries Association (EIA) standard that defines the connector, connector pins, and signals used to transfer data serially from one device to another.

S

Scan Area. Area intended to contain a symbol.

Scanner. An electronic device used to scan bar code symbols and produce a digitized pattern that corresponds to the bars and spaces of the symbol. Its three main components are: 1) Light source (laser or photoelectric cell) - illuminates a bar code; 2) Photodetector - registers the difference in reflected light (more light reflected from spaces); 3) Signal conditioning circuit - transforms optical detector output into a digitized bar pattern.

Scanning Mode. The scanner is energized, programmed and ready to read a bar code.

Scanning Sequence. A method of programming or configuring parameters for a bar code reading system by scanning bar code menus.

SDK. Software Development Kit

Self-Checking Code. A symbology that uses a checking algorithm to detect encoding errors within the characters of a bar code symbol.

Shared Key. Shared Key authentication is an algorithm where both the AP and the MU share an authentication key.

SHIP. Symbol Host Interface Program.

- SID.** System Identification code. An identifier issued by the FCC for each market. It is also broadcast by the cellular carriers to allow cellular devices to distinguish between the home and roaming service.
- Soft Reset.** See **Warm Boot**.
- Space.** The lighter element of a bar code formed by the background between bars.
- Specular Reflection.** The mirror-like direct reflection of light from a surface, which can cause difficulty decoding a bar code.
- Standard Trigger Mode.** The digital scanner uses this mode when lifted off the counter or removed from the wall mount. In this mode, aim the digital scanner at a bar code and pull the trigger to decode.
- Start/Stop Character.** A pattern of bars and spaces that provides the scanner with start and stop reading instructions and scanning direction. The start and stop characters are normally to the left and right margins of a horizontal code.
- STEP.** Symbol Terminal Enabler Program.
- Subnet.** A subset of nodes on a network that are serviced by the same router. See **Router**.
- Subnet Mask.** A 32-bit number used to separate the network and host sections of an IP address. A custom subnet mask subdivides an IP network into smaller subsections. The mask is a binary pattern that is matched up with the IP address to turn part of the host ID address field into a field for subnets. Default is often 255.255.255.0.
- Substrate.** A foundation material on which a substance or image is placed.
- SVTP.** Symbol Virtual Terminal Program.
- Symbol.** A scannable unit that encodes data within the conventions of a certain symbology, usually including start/stop characters, quiet zones, data characters and check characters.
- Symbol Aspect Ratio.** The ratio of symbol height to symbol width.
- Symbol Height.** The distance between the outside edges of the quiet zones of the first row and the last row.
- Symbol Length.** Length of symbol measured from the beginning of the quiet zone (margin) adjacent to the start character to the end of the quiet zone (margin) adjacent to a stop character.
- Symbology.** The structural rules and conventions for representing data within a particular bar code type (e.g. UPC/EAN, Code 39, PDF417, etc.).

T

- TCP/IP.** (Transmission Control Protocol/Internet Protocol) A communications protocol used to internetwork dissimilar systems. This standard is the protocol of the Internet and has become the global standard for communications. TCP provides transport functions, which ensures that the total amount of bytes sent is received correctly at the other end. UDP is an alternate transport that does not guarantee delivery. It is widely used for real-time voice and video transmissions where erroneous packets are not retransmitted. IP provides the routing mechanism. TCP/IP is a routable protocol, which means that all messages contain not only the address of the destination station, but the address of a destination network. This allows TCP/IP messages to be sent to multiple networks within an organization or around the world, hence its use in the worldwide Internet. Every client and server in a TCP/IP network requires an IP address, which is either permanently assigned or dynamically assigned at startup.

Telnet. A terminal emulation protocol commonly used on the Internet and TCP/IP-based networks. It allows a user at a terminal or computer to log onto a remote device and run a program.

Terminal Emulation. A “terminal emulation” emulates a character-based mainframe session on a remote non-mainframe terminal, including all display features, commands and function keys. The VC5000 Series supports Terminal Emulations in 3270, 5250 and VT220.

Terminate and Stay Resident (TSR). A program under DOS that ends its foreground execution to remain resident in memory to service hardware/software interrupts, providing background operation. It remains in memory and may provide services on behalf of other DOS programs.

TFTP. (Trivial File Transfer Protocol) A version of the TCP/IP FTP (File Transfer Protocol) protocol that has no directory or password capability. It is the protocol used for upgrading firmware, downloading software and remote booting of diskless devices.

Tolerance. Allowable deviation from the nominal bar or space width.

Transmission Control Protocol/Internet Protocol. See **TCP/IP**.

Trivial File Transfer Protocol. See **TFTP**.

TSR. See **Terminate and Stay Resident**.

U

UDP. User Datagram Protocol. A protocol within the IP protocol suite that is used in place of TCP when a reliable delivery is not required. For example, UDP is used for real-time audio and video traffic where lost packets are simply ignored, because there is no time to retransmit. If UDP is used and a reliable delivery is required, packet sequence checking and error notification must be written into the applications.

UPC. Universal Product Code. A relatively complex numeric symbology. Each character consists of two bars and two spaces, each of which is any of four widths. The standard symbology for retail food packages in the United States.

V

Visible Laser Diode (VLD). A solid state device which produces visible laser light.

W

Warm Boot. A warm boot restarts the mobile computer by closing all running programs. All data that is not saved to flash memory is lost.

INDEX

Numerics

123Scan2 9-1

A

ADF 10-1
advanced data formatting 10-1
aiming 2-4
ASCII values
 full ASCII code 39 encode character G-1
 keyboard wedge 6-11
 keystroke G-1
 RS-232 4-20
 USB 3-17
assembling the stand 1-4

B

bar code defaults
 all A-1
 IBM 5-3
 keyboard wedge 6-3
 misc options 7-3
 RS-232 4-3
 symbolologies 8-2
 USB 3-4
 user preferences 7-2, 7-5
bar codes
 beep after good decode 7-7
 beeper duration 7-11
 beeper tone 7-9
 beeper volume 7-10
 bi-directional redundancy 8-70
 bookland EAN 8-9
 bookland ISBN 8-20
 buffering 8-34

cancel E-3
Chinese 2 of 5 8-59
codabar 8-51
codabar CLSI editing 8-53
codabar lengths 8-51
codabar NOTIS editing 8-53
codabar start and stop characters 8-54
code 11 8-39
code 11 lengths 8-39
code 128 8-23
code 128 lengths 8-23
code 128 security level 8-28
code 39 8-29
 transmit buffer 8-35
code 39 check digit verification 8-32
code 39 full ASCII 8-33
code 39 lengths 8-31
code 39 transmit check digit 8-32
code 93 8-37
code 93 lengths 8-37
code39 security level 8-36
continuous bar code read 7-17
convert GS1 databar to UPC/EAN 8-67
convert UPC-E to UPC-A 8-19
convert UPC-E1 to UPC-A 8-19
country code page defaults B-2
decode session timeout 7-18
direct decode indicator 7-8
disable all code types 8-6
discrete 2 of 5 8-49
 lengths 8-50
EAN zero extend 8-20
EAN-13/JAN-13 8-9
EAN-8/JAN-8 8-8
enter key 7-27
FN1 substitution values 7-24
GS1 databar 8-64

- GS1 databar expanded 8-65
- GS1 databar limited 8-64
- GS1 databar-14 8-64
- GS1-128 8-25
- hands-free mode 7-13
- I 2 of 5 check digit verification 8-45
- I 2 of 5 convert to EAN-13 8-46
- I 2 of 5 security level 8-47
- I 2 of 5 transmit check digit 8-45
- IBM 468X/469X
 - convert unknown to code 39 5-5
 - ignore bar code configuration 5-6
 - ignore beep 5-5
 - port address 5-4
- interleaved 2 of 5 8-43
 - convert to EAN-13 8-28, 8-46, 8-47
 - lengths 8-43
- ISBT 128 8-25
- ISBT concatenation 8-26, 8-27
- ISBT concatenation redundancy 8-27
- ISSN EAN 8-22
- keyboard wedge
 - alternate numeric keypad emulation 6-6
 - caps lock on 6-7
 - caps lock override 6-7
 - host types 6-4
 - ignore unknown characters 6-4
 - intra-keystroke delay 6-5
 - keystroke delay 6-5
 - quick keypad emulation 6-6
- Korean 3 of 5 8-63
- matrix 2 of 5 8-60
- matrix 2 of 5 check digit 8-62
- matrix 2 of 5 lengths 8-60, 8-61
- MSI 8-55
- MSI check digit algorithm 8-58
- MSI check digits 8-57
- MSI lengths 8-55
- MSI transmit check digit 8-57
- numeric bar codes E-3
- parameter scanning 7-7
- power mode 7-14
- prefix/suffix values 7-21
- redundancy level 8-68
- report version 7-6
- RS-232
 - baud rate 4-8
 - beep on 4-17
 - check receive errors 4-12
 - data bits 4-10
 - hardware handshaking 4-12, 4-13
 - host serial response time-out 4-16
 - host types 4-6, 4-7
 - ignore unknown characters 4-19
 - intercharacter delay 4-18
 - Nixdorf Beep/LED options 4-19
 - parity 4-11
 - RTS line state 4-17
 - software handshaking 4-14
 - stop bit select 4-9
- scan data options 7-22
- security level 8-71
- set defaults 1-6, 7-4
- supplementals 8-10
- suppress power-up beeps 7-8
- symbolologies
 - default table 8-2
 - GS1 databar limited 8-65, 8-66
- tab key 7-27
- time delay to low power mode 7-15
- timeout between decodes, different symbols 7-19
- timeout between decodes, same symbol 7-19
- transmit code ID character 7-20
- transmit matrix 2 of 5 check digit 8-62
- transmit no read message 7-25
- trigger modes 7-12
- UCC coupon extended code 8-21
- unique bar code reporting 7-17
- unsolicited heartbeat interval 7-26
- UPC/EAN
 - coupon code 8-21
 - supp redundancy 8-13, 8-14
- UPC/EAN/JAN
 - supplemental AIM ID format 8-14
 - supplemental redundancy 8-13
- UPC-A 8-7
- UPC-A preamble 8-16
- UPC-A/E/E1 check digit 8-15, 8-16
- UPC-E 8-7
- UPC-E preamble 8-17
- UPC-E1 8-8
- USB
 - caps lock override 3-7
 - convert case 3-12
 - device type 3-5, 3-6
 - emulate keypad 3-9
 - emulate keypad with leading zero 3-9
 - fast HID keyboard 3-14
 - function key mapping 3-11
 - keyboard FN 1 sub 3-10
 - keystroke delay 3-7
 - optional parameters 3-16
 - polling interval 3-13, 3-14
 - quick keyboard emulation 3-10
 - simulated caps lock 3-11
 - SNAPI handshaking 3-6
 - static CDC 3-15
 - unknown characters 3-8

beeper definitions 2-1
 bullets xv

C

cables
 installing 1-3
 character set 3-17, 4-20, 6-11
 codabar bar codes
 CLSI editing 8-53
 codabar 8-51
 lengths 8-51
 NOTIS editing 8-53
 start and stop characters 8-54
 code 11 bar codes
 code 11 8-39
 lengths 8-39
 code 128 bar codes
 code 128 8-23
 GS1-128 8-25
 ISBT 128 8-25
 ISBT concatenation 8-26, 8-27
 ISBT concatenation redundancy 8-27
 lengths 8-23
 security level 8-28
 code 39 bar codes
 buffering 8-34
 check digit verification 8-32
 code 39 8-29
 full ASCII 8-33
 lengths 8-31
 security level 8-36
 transmit check digit 8-32
 code 93 bar codes
 code 93 8-37
 lengths 8-37
 code ID character 7-20
 code identifiers
 AIM code IDs C-2
 modifier characters C-3
 Symbol C-1
 configurations
 scanner xiii
 connecting power 1-3
 conventions
 notational xv
 country code page defaults B-2

D

decode ranges 2-5
 default parameters 7-2
 all A-1
 IBM 5-3

keyboard wedge 6-3
 misc options 7-3
 RS-232 4-3
 standard default table G-1
 symbologies 8-2
 USB 3-4
 user preferences 7-2, 7-5
 discrete 2 of 5 bar codes
 discrete 2 of 5 8-49

E

error indications
 ack/nak 4-14
 enq 4-14
 RS-232 transmission 4-12
 transmission 4-16
 unknown characters 3-8, 4-19, 6-4
 xon/xoff 4-14

G

GS1 databar 8-64
 convert GS1 databar to UPC/EAN 8-67

H

host types
 IBM (port address) 5-4
 keyboard wedge 6-4
 RS-232 4-6, 4-7
 USB 3-5, 3-6

I

IBM 468X/469X connection 5-2
 IBM 468X/469X parameters 5-4
 IBM defaults 5-3
 indications
 beeper 2-1
 LED 2-2
 information, service xvi
 interleaved 2 of 5 bar codes
 check digit verification 8-45
 convert to EAN-13 8-46
 security level 8-47
 transmit check digit 8-45

K

keyboard types (country codes)
 Albanian B-6
 Arabic (101) B-6
 Arabic (102) B-6

Arabic (102) Azerty	B-6	Polish (214)	B-15
Azeri (Cyrillic)	B-7	Polish (Programmer)	B-15
Azeri (Latin)	B-7	Portuguese (Brazil)	B-15
Belarusian	B-7	Portuguese (Brazilian ABNT)	B-15
Bosnian (Cyrillic)	B-7	Portuguese (Brazilian ABNT2)	B-15
Bosnian (Latin)	B-7	Portuguese (Portugal)	B-16
Bulgarian (Latin)	B-7	Romanian	B-16
Bulgarian Cyrillic (Typewriter)	B-8	Romanian (Legacy)	B-16
Canadian French (Legacy)	B-8	Romanian (Programmer)	B-16
Canadian French Win7	B-8	Romanian (Standard)	B-16
Canadian Multilingual Standard	B-8	Russian	B-16
Chinese (ASCII)	B-8	Russian (Typewriter)	B-17
Croatian	B-9	Serbian (Cyrillic)	B-17
Czech	B-9	Serbian (Latin)	B-17
Czech (Programmer)	B-9	Slovak	B-17
Czech (QWERTY)	B-9	Slovak (QWERTY)	B-17
Danish	B-9	Slovenian	B-17
Dutch (Netherlands)	B-9	Spanish	B-17
Estonian	B-10	Spanish (Variation)	B-18
Faeroese	B-10	Swedish	B-18
Finnish	B-10	Swiss French	B-18
French (Canada) 2000/XP	B-11	Swiss German	B-18
French (Canada) 95/98	B-10	Tatar	B-18
French (France)	B-10	Thai (Kedmanee)	B-18
French International	B-10	Turkish F	B-18
Galician	B-11	Turkish Q	B-19
German	B-11	UK English	B-19
Greek	B-11	Ukranian	B-19
Greek (220) Latin	B-11	US Dvorak	B-19
Greek (319) Latin	B-11	US Dvorak Left	B-19
Greek 220	B-12	US Dvorak Right	B-19
Greek 319	B-12	US English	B-6
Greek Latin	B-11	US International	B-20
Greek Polytonic	B-12	Uzbek	B-20
Hebrew Israel	B-12	Vietnamese	B-20
Hungarian	B-12	keyboard wedge connection	6-2
Hungarian_101KEY	B-12	keyboard wedge defaults	6-3
Irish	B-13	keyboard wedge parameters	6-4
Islandic	B-12	Korean 3 of 5 bar codes	8-63
Italian	B-13		
Italian (142)	B-13	L	
Japanese (ASCII)	B-13	LED definitions	2-2
Kazakh	B-13		
Korean (ASCII)	B-13	M	
Kyrgyz	B-13	maintenance	11-1
Latin American	B-14	matrix 2 of 5 bar codes	8-60
Latvian	B-14	check digit	8-62
Latvian (QWERTY)	B-14	lengths	8-60, 8-61
Lithuanian	B-14	transmit check digit	8-62
Lithuanian (IBM)	B-14	misc options defaults	7-3
Macedonian (FYROM)	B-14	mounting the stand	1-5
Maltese_47KEY	B-14	MSI bar codes	
Mongolian	B-15		
Norwegian	B-15		

- check digit algorithm 8-58
 - check digits 8-57
 - lengths 8-55
 - MSI 8-55
 - transmit check digit 8-57
- N**
- notational conventions xv
- P**
- parameter defaults
 - all A-1
 - IBM 5-3
 - keyboard wedge 6-3
 - misc options 7-3
 - RS-232 4-3
 - USB 3-4
 - parameters
 - IBM 468X/469X 5-4
 - keyboard wedge 6-4
 - RS-232 4-4
 - set defaults 1-6, 7-4
 - symbolgies 8-6
 - USB 3-5
 - user preferences 7-4
 - parts 1-2
 - pinouts
 - scanner signal descriptions 11-6
 - power mode 7-14
 - power supply
 - connecting 1-3
 - Preferences 7-4
- R**
- RS-232 connection 4-2
 - RS-232 defaults 4-3
 - RS-232 parameters 4-4
- S**
- sample bar codes
 - code 128 D-2
 - code 39 D-1
 - GS1 DataBar D-3
 - interleaved 2 of 5 D-2
 - UPC/EAN D-1
 - scanner configurations xiii
 - scanner defaults 7-2
 - scanner parts 1-2
 - scanning 2-3
 - aiming 2-4
 - decode ranges 2-5
 - errors 3-8, 6-4, 7-2, 8-1
 - hand-held 2-3
 - hands-free 2-4
 - sequence example 7-1, 8-1
 - trigger modes 7-12
 - security level 8-71
 - service information xvi
 - setup
 - connecting a USB interface 3-2
 - connecting an RS-232 interface 4-2
 - connecting keyboard wedge interface 6-2
 - connecting power 1-3
 - connecting power supply 1-3
 - connecting to an IBM 468X/469X host 5-2
 - installing the cable 1-3
 - signal descriptions 11-6
 - specifications 11-4
 - stand
 - assembling 1-4
 - mounting 1-5
 - standard default parameters G-1
 - standard defaults 7-2
 - symbolgy default parameters 8-2
- T**
- technical specifications 11-4
- U**
- UPC/EAN bar codes
 - bookland EAN 8-9
 - bookland ISBN 8-20
 - check digit 8-15, 8-16
 - convert UPC-E to UPC-A 8-19
 - convert UPC-E1 to UPC-A 8-19
 - EAN zero extend 8-20
 - EAN-13/JAN-13 8-9
 - EAN-8/JAN-8 8-8
 - ISSN EAN 8-22
 - supplementals 8-10
 - UCC coupon extended code 8-21
 - UPC-A 8-7
 - UPC-A preamble 8-16
 - UPC-E 8-7
 - UPC-E preamble 8-17
 - UPC-E1 8-8
 - USB connection 3-2
 - USB defaults 3-4
 - USB parameters 3-5
 - user preferences bar codes
 - set defaults 1-6, 7-4
 - user preferences parameters 7-2, 7-5



Zebra Technologies Corporation
Lincolnshire, IL U.S.A.
<http://www.zebra.com>

Zebra and the Zebra head graphic are registered trademarks of ZIH Corp. The Symbol logo is a registered trademark of Symbol Technologies, Inc., a Zebra Technologies company.

© 2015 Symbol Technologies Inc.



MN000754A02 Revision A March 2015

